

# SAFETY PROMOTION NOTICE

**SUBJECT: GENERAL**

**ESPN-R Hoist Task Force recommendations & Airbus Helicopters additional notes**

For the attention of



AIRCRAFT CONCERNED	Version(s)	
	Civil	Military
EC120	B	
AS350	B, BA, BB, B1, B2, B3, D	L1
AS550		A2, C2, C3, U2
AS355	E, F, F1, F2, N, NP	
AS555		AF, AN, SN, UF, UN, AP
EC130	B4, T2	
SA365 / AS365	C1, C2, C3, N, N1, N2, N3	F, Fs, Fi, K, K2
AS565		MA, MB, SA, SB, UB, MBe
SA366		GA
EC155	B, B1	
SA330	J	Ba, L, Jm, S1, Sm
SA341	G	B, C, D, E, F, H
SA342	J	L, L1, M, M1, Ma
ALOUETTE II	313B, 3130, 318B, 318C, 3180	
ALOUETTE III	316B, 316C, 3160, 319B	
LAMA	315B	
EC225	LP	
EC725		AP
AS332	C, C1, L, L1, L2	B, B1, F1, M, M1
AS532		A2, U2, AC, AL, SC, UE, UL
EC175	B	
EC339		KUH/Surion
BO105	C (C23, CB, CB-4, CB-5), D (DB, DBS, DB-4, DBS-4, DBS-5), S (CS, CBS, CBS-4, CBS-5), LS A-3	CBS-5 KLH, E-4
MBB-BK117	A-1, A-3, A-4, B-1, B-2, C-1, C-2, C-2e, D-2, D-2m	D-2m
EC135	T1, T2, T2+, T3, P1, P2, P2+, P3, EC635 T1, EC635 T2+, EC635 T3, EC635 P2+, EC635 P3, T3H, P3H, EC635 T3H, EC635 P3H	

With revision 1 of this Safety Promotion Notice (SPN), Airbus Helicopters provides as an add-on and under the same SPN numbering additional information on hoist missions and operations, partially specifically tailored to aircraft configurations and missions that are only available or seen with Airbus Helicopters types.

The aforementioned add-on was not developed by the ESPN-R Hoist Safety Task Force, but by Airbus Helicopters. Airbus Helicopters invites the ESPN-R working group and operators to contribute by providing information about their best practice and / or their specific hoist operations.

The first ESPN-R part, section 1 until page 41 remains unchanged but can also be extended in the future when ESPN-R information evolves. The add-on by Airbus Helicopters starts on page 41.

If you want to provide feedback, you can contact us at [contact.aviationsafety.ah@airbus.com](mailto:contact.aviationsafety.ah@airbus.com)

<b>1. ESPN-R TASK FORCE RECOMMENDATIONS .....</b>	<b>3</b>
<b>1.1 INTRODUCTION.....</b>	<b>3</b>
<b>1.2 HISTORY OF HOIST USE IN THE ROTORCRAFT INDUSTRY .....</b>	<b>3</b>
<b>1.3 LESSONS LEARNT IN OPERATIONS: EQUIPMENT .....</b>	<b>5</b>
<b>1.4 LESSONS LEARNT IN OPERATIONS: BRIEFING PRACTICES .....</b>	<b>10</b>
<b>1.5 LESSONS LEARNT IN OPERATIONS: SAFETY ACTIONS .....</b>	<b>13</b>
<b>1.6 LESSONS LEARNT IN OPERATIONS: PROBLEM MANAGEMENT .....</b>	<b>24</b>
<b>1.7 TESTIMONY .....</b>	<b>27</b>
<b>1.8 LESSONS LEARNT IN OPERATIONS: TRAINING .....</b>	<b>27</b>
<b>1.9 LESSONS LEARNT IN OPERATIONS: IT &amp; MAINTENANCE .....</b>	<b>32</b>
<b>2. AIRBUS HELICOPTERS ADDITIONAL NOTES.....</b>	<b>39</b>
<b>2.1 SUPPORTING MODIFICATIONS.....</b>	<b>39</b>
<b>2.2 OPERATIONAL RECOMMENDED PRACTICES.....</b>	<b>42</b>

## 1. ESPN-R TASK FORCE RECOMMENDATIONS

### 1.1 INTRODUCTION

This document and the following information are the result of the ESPN-R hoist task force study and analysis.



### 1.2 HISTORY OF HOIST USE IN THE ROTORCRAFT INDUSTRY

At its inception (from approx. 1950), the rescue hoist system was designed and used to save people (on the ground and on the sea) out of distress situations in SAR / MEDEVAC type missions. The operators were mainly military.



From the 1970s on, the hoist became more robust and popular on lighter helicopters; non-military, governmental and non-governmental organizations started to adopt its use to save lives.



From approximately the early 1990s, helicopter hoists started to be used as transportation means for harbor pilot transfers off-shore, when vessels were not able to perform the transfer - this was the first use of rescue equipment as a personal transport device.



From the mid-2000s, the off-shore wind turbine industry grew and the helicopter with its hoist was a safe vehicle system to transfer maintenance staff to the wind turbines.



Along with the continuous development of renewable energies, the helicopter industry expects a significant growth in this last sector. To ensure a safe and efficient operation, EASA has established together with the helicopter industry a working group to publish best practices, safety recommendations, training standards and review certification requirements.

### 1.3 LESSONS LEARNT IN OPERATIONS: EQUIPMENT

#### 1.3.1 PCDS / PSE & PAX

##### 1.3.1.1 PCDS - Personnel Carrying Device System



Risk to be prevented: use of unapproved/unairworthy/expired/non-standard equipment by ground forces.

Risk prevention & mitigation strategies:

- standardization of PCDS for persons transported on the hoist hook,
- no textile interfaces / loops allowed in hoist hook in compliance with CM CS 005 issue 1 / CS27 Amd.5 & CS29 Amd.5 (link [here](#)).

**1.3.1.2 PSE - Personal Safety Equipment for Hoist Operators, Rescuers, Hoist passengers**

Appropriate head & eye protection,  
Flight or survival suit  
Rescue / emergency knife  
Shoes

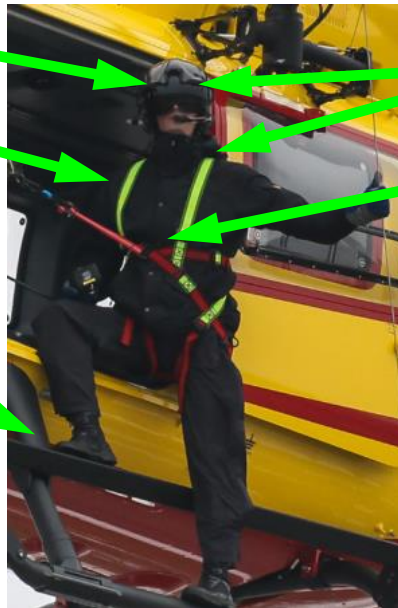

Protection against environmental conditions, wind, rain, dust, particles, water, etc.

PCDS with quick disconnect link



Appropriate head and eye protection  
Flight or survival suit  
Radio equipment  
Rescue / emergency knife

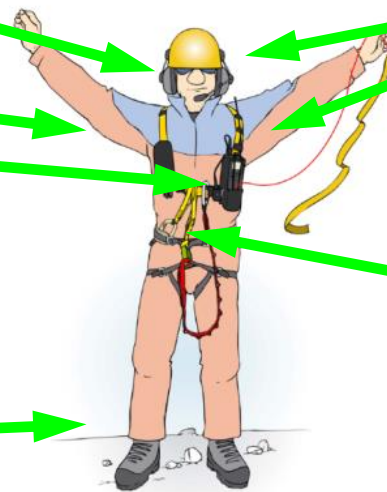

Protection against environmental conditions, wind, rain, dust, particles, water, etc.

PCDS

Shoes

Depending on the mission:  
backpack with specific mission equipment...

Risk to be prevented: injuries to the hoist operator, rescuer or hoist passenger.

Risk prevention & mitigation strategies:

- standardized PSE for hoist operators and extended to other crew, including hoisting gloves,
- standardized PSE & PCDS for rescuers and hoist passengers; extended to other crew, including hoisting gloves,
- the Hoist Operator, Rescuer, Hoist Passenger harnesses should be provided generally with a quick release system to be able to detach and escape the cabin even under load conditions on the harness, for instance by being equipped with a rescue knife.

**1.3.1.3 PSE - Personal Safety Equipment for the victim**

Rescue Stretcher / Bag



Rescue Triangle

**Rescue Sling - mainly for water rescue**  
 with potential risk of loss of load and NOT recommended for HEC

Risk to be prevented: additional victim injuries.

Risk prevention & mitigation strategies:

- standardization of rescue equipment for victims within organizations, to ensure safe, quick and easy application to the person being hoisted,
- no untrained (or incapacitated / unconscious) persons to be hoisted unattended.

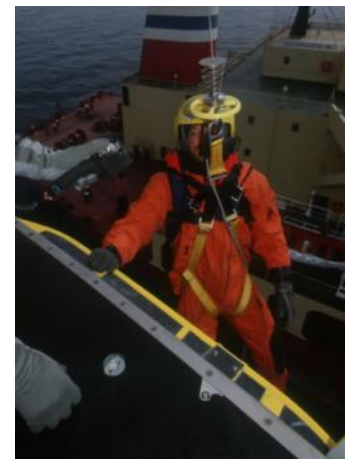
**1.3.1.4 Off-shore Passenger Emergency Equipment Configuration**

Risk to be prevented: use of equipment designed for ship-side use and not for helicopter operations/transfer.

Risk prevention & mitigation strategies:

- Use equipment designed for use with helicopters (life vests, survival suits, life rafts...) which take into account the specific context (non-automatic deployment, release system, lift & boost issues...).

1.3.1.5 Off-shore hoisting - cabin securing devices shall be releasable under load



Risk to be prevented: crew or passengers unable to release cabin securing devices after ditching.

Risk prevention & mitigation strategies:

- cabin securing devices shall be releasable under load,
- this may also be considered in OPS regulations,
- alternatively, a rescue knife / belt cutter may be used.



### 1.3.2 ADAPTATION / COMPATIBILITY

#### 1.3.2.1 Helicopter attached to the ground



Risk to be prevented: an entanglement where the helicopter is attached to the ground through the rescuer.

Risk prevention & mitigation strategies:

- There exists specific devices like the Norwegian ARS or the Petzl Lezard → Video [link](#)

#### 1.3.2.2 Dynamic rollout phenomena on hoist hooks

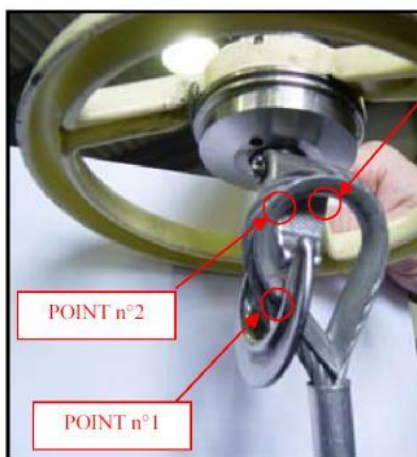

Risk to be prevented: dynamic disengagement of hoist hook, link of D-LOK hook disengagement/rollout.

Risk prevention & mitigation:

- all crew members involved in hoist and/or external sling load operations shall be trained and attentive to the dynamic rollout (ring reversal) phenomenon,
- hook and equipment shall be checked for compatibility prior to flight.

## 1.4 LESSONS LEARNT IN OPERATIONS: BRIEFING PRACTICES

### 1.4.1 MISSION BRIEFING ON THE GROUND & IN FLIGHT



Risk to be prevented: incoherent actions by the crew.

Risk prevention & mitigation strategies:

- create a clear briefing concept,
- if unavailable, mitigation can be simple questioning of crew members, such as: "are we really going to location XYZ?" to motivate communication between crew members & create situational awareness.

### 1.4.2 HOIST PASSENGER TRAINING AND BRIEFING



Risk to be prevented: untrained / un-briefed personnel to be transported on the hoist hook.

Risk prevention & mitigation strategies:

- Hoist Passenger training and briefing based on:
- Passenger check list for hoist operations, including clear instructions on cable handling (too much slack of cable to be avoided, "Danger of static electricity"..) and basics of the helicopter safety, performance, etc.

**1.4.3 VOICE AND VISUAL COMMANDS FOR THE RESCUER ON THE GROUND**

**Normal**

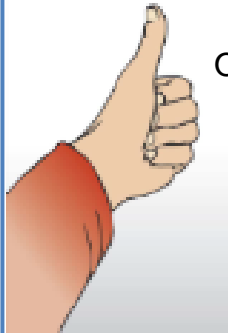

OK!



Helicopter  
tied to the  
ground

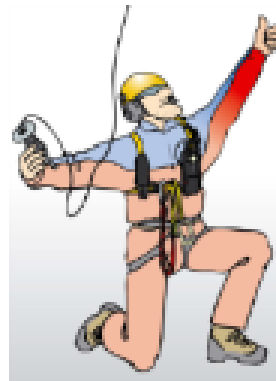

Cable  
free to  
reel in

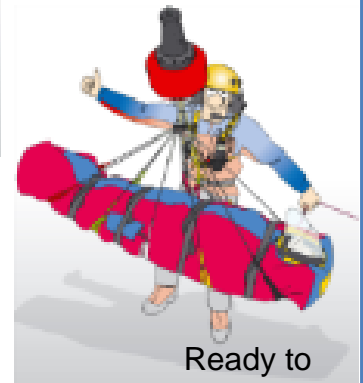

Ready to  
hoist up



XX  
meters to  
the  
ground



Helicopter  
tied to the  
ground

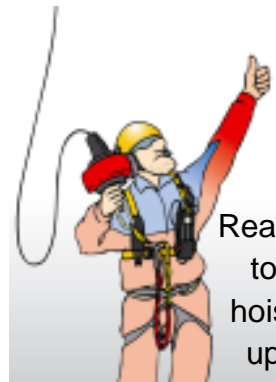

Ready  
to  
hoist  
up

**Emergency/abnormal**

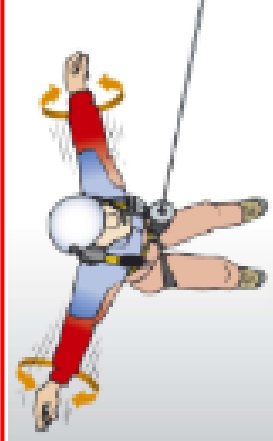

Abort hoist operation



Disconnect from Hook

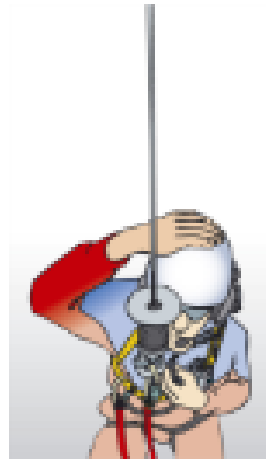

Loss of radio com



Pay attention

Risk to be prevented: lack of clarity in communication.

Risk prevention & mitigation strategies:

- voice and visual commands for all involved in the hoist operation must be clear, limited and standardized to provide essential and minimum information,
- this standard must be part of an intensive initial and recurrent training,
- revise CRM concept (created for a cockpit of 2 or more crew members: pilots, Flight Engineer and Navigator) as it did not take into account specific mission and crew involved in rescue, law enforcement and other missions. Not only must the hoist operator be involved but also other crew members such as HEC.

## 1.5 LESSONS LEARNT IN OPERATIONS: SAFETY ACTIONS

### 1.5.1 GROUND BOARDING WITH ROTOR TURNING

#### 1.5.1.1 Motion sequence while embarking / disembarking

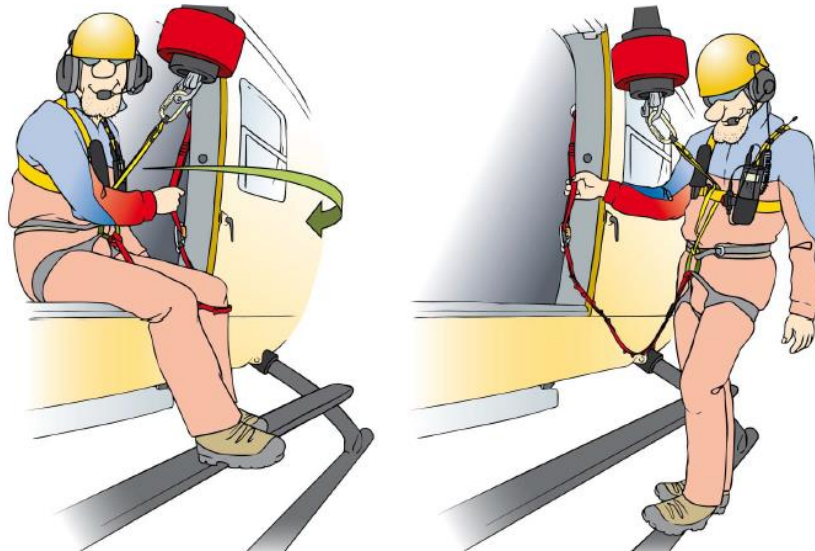

Risk to be prevented: entanglement, loss of load.

Risk prevention & mitigation strategies:

- Standardization in SOP of motion sequence during boarding and disembarking.
- Equipment (backpack, ski, dog, etc.) stowage and loading sequence must be standardized and briefed in advance.

#### 1.5.1.2 Managing untrained persons (by-standers) approaching a helicopter

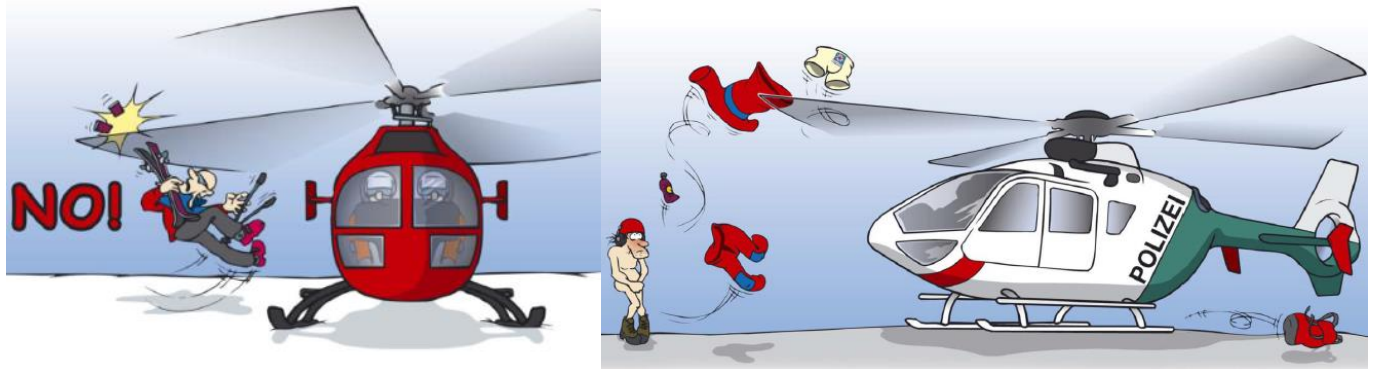

Risk to be prevented: lack of situation awareness of untrained persons.

Risk prevention & mitigation strategies:

- Guard/escort hoist passengers when possible - (similar to operations at public heliports).

## 1.5.2 CABIN SAFETY / HOIST OPERATOR

### 1.5.2.1 Hoist operator securing in the cabin

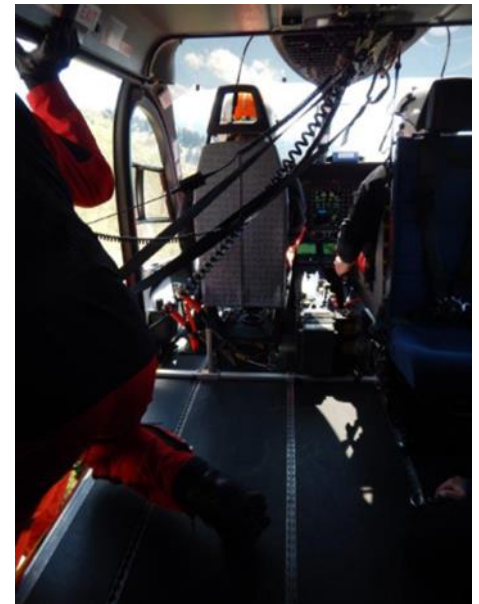

Risk to be prevented: hoist operator not secured in cabin.

Risk prevention & mitigation strategies:

- request “confirm secured” question by PIC standardization / checklist “before hoist operation / opening of door”,
- leverage four eye principle / perform **buddy check** as performed by scuba divers.

### 1.5.2.2 Cabin Safety 1/3

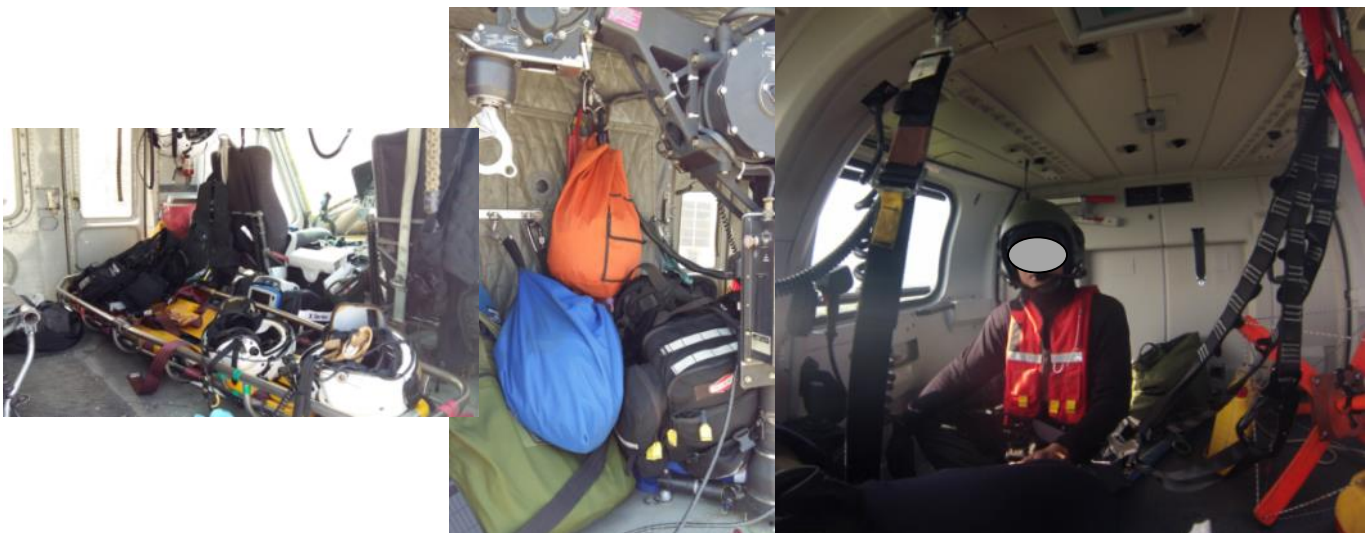

Risk to be prevented: non-secured jacket / backpack / loose equipment

Risk prevention & mitigation strategies:

- all objects stowed & secured,
- seats to be taken by all passengers / crew members during take-off, landing and flight,
- sliding door shall be closed whenever possible.

1.5.2.3 Cabin Safety 2/3



Risk to be prevented: unnecessary items brought in flight (loose objects & potential impact on performance).

Risk prevention & mitigation strategies:

- Bring the minimum of additional mission equipment for the flight crew, reduce to what is really essential / required to perform the mission.

1.5.2.4 Cabin Safety 3/3



Risk to be prevented: more than 1 harness connected to a hard point (safety point).

Risk prevention & mitigation strategies:

- in flight, prior to opening the door, the cabin shall be secured and the Hoist Operator harness attached on one hard point and cross-checked by the other crew members,
- ONE HARD POINT (SAFETY POINT) = ONE HARNESS ONLY.



### 1.5.3 RECOMMENDATIONS & CHECKLIST BEFORE HOISTING

#### 1.5.3.1 Reconnaissance fly-over



Risk to be prevented: Vortex Ring State, main or tail rotor impact, entanglement, FOD by any loose ground object.  
Risk prevention & mitigation strategies:

- mandate in SOP 2 reconnaissance fly-overs before initiation of hoist operation to evaluate terrain, wind, visibility, briefing of hoist operation, e.g. power setting, emergencies and escape path, alternate, etc.,
  - o A high pass in order to understand the operating zone (wind, main obstacles as powerlines, high trees, animals or crowd on the ground etc., Way in, way out/ Escape route, clearance to descend).
  - o Low pass to understand the hoisting area and confirmed A/C performance, winching height, escape route.
- no hoist ops should be performed without a situation assessment before commitment to hover.

### 1.5.3.2 Situation assessment by persons on the ground



Risk to be prevented: lack of experience/training of persons on the ground.

Risk prevention & mitigation strategies:

- do not rely exclusively on situation & site assessment by persons on the ground,
- all information provided is to be confirmed by the crew during fly-over.

### 1.5.3.3 Checklists

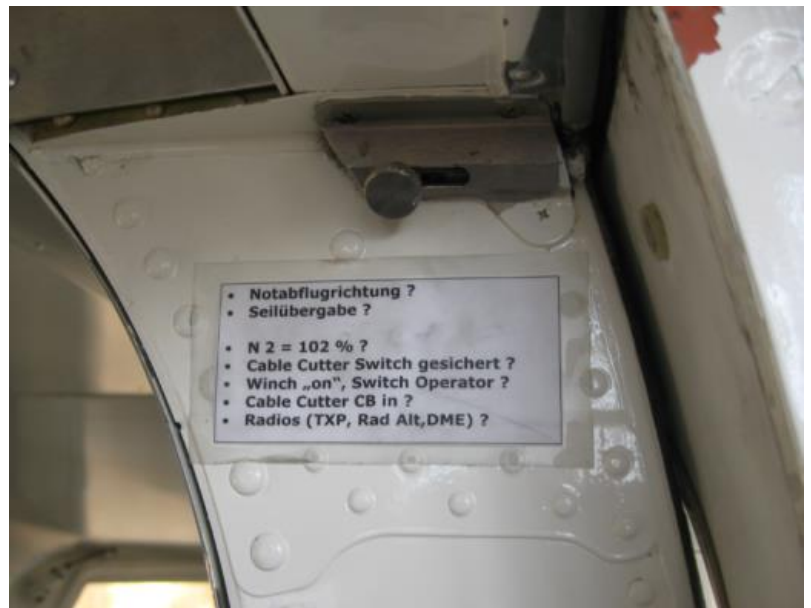

Risk to be prevented: operational & situational awareness.

Risk prevention & mitigation strategies:

- establish short and pragmatic checklists.
- create & use standardized wording / commands for external loads.

#### 1.5.3.4 Safety check prior to hoisting up



Risk to be prevented:

- entanglement or hooking of harness,
- unintended detachment during initial lift off.

Risk prevention & mitigation strategies: the goal is to ensure that the rigging and equipment have been checked and that the load is clear of obstructions.

- a safety check should be performed prior to the extraction of HEC (human external cargo),
- once the pilot is satisfied and considers the check complete, he is clear to depart the scene.

## 1.5.4 HOISTING

### 1.5.4.1 Shock Load on hoist cable and/or hoist passenger



Risk to be prevented: shock load on the cable.

Risk prevention & mitigation strategies:

- position the HEC in order to avoid “falling into” the rope or cable,
- prepare a controlled progressive tensioning of the cable and departure.

### 1.5.4.2 Helicopter attached/tied to the ground, normal and emergency

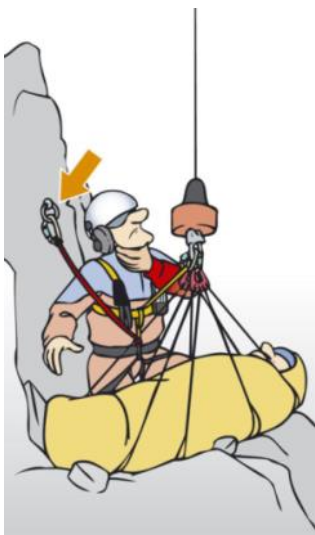

Risk to be prevented: aircraft-side crew unaware that the helicopter is attached to the ground.

Risk prevention & mitigation strategies:

- setup and use clear hand-signals to the hoist operator / flight crew when no radio communication available or possible,
- always maintain visual contact.

#### 1.5.4.3 Hoist Operator positioning in the helicopter (with wheel landing gear)



Risk to be prevented: unstable position of the hoist operator.

Risk prevention & mitigation strategies, related to hoist operator positioning for helicopters with retractable landing gear (and no articulating boom):

- the HO shall not have the full body outside the cabin with the two feet on the footstep,
- the best positions are: one knee (or foot) on the cabin floor and one foot on the step; or two knees (or feet) on the cabin floor.
- the lanyard length of the hoist operator harness must be set to prevent the HO from falling outside the cabin.

#### 1.5.4.4 Hoist Operator positioning outside the helicopter (with skid landing gear)

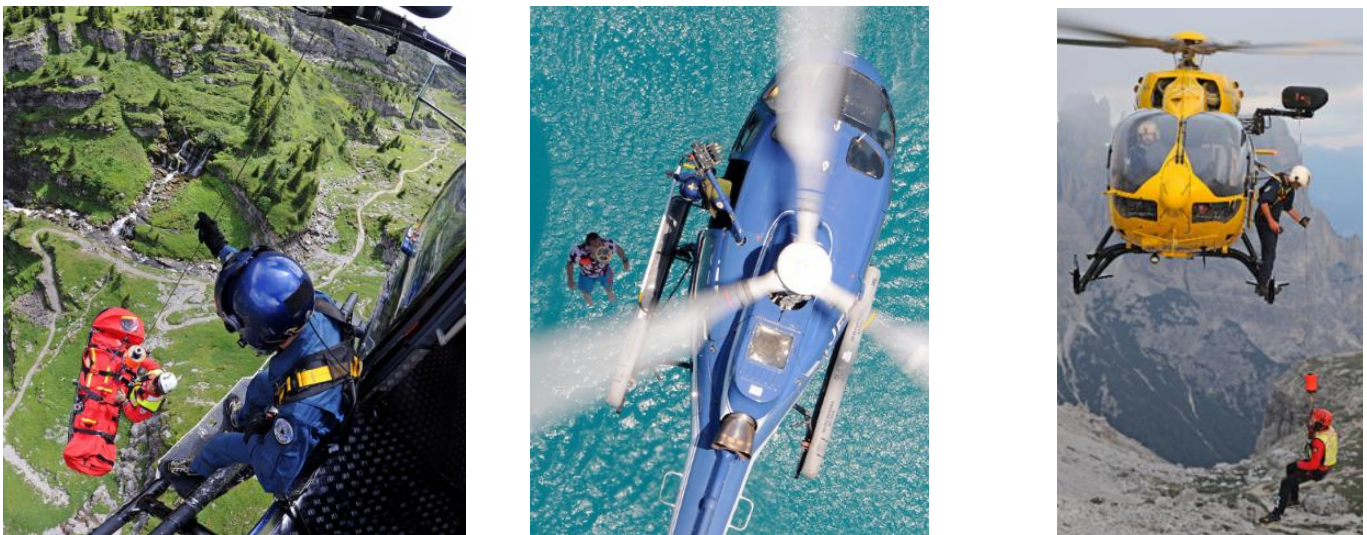

Risk to be prevented: unstable position of the hoist operator.

Risk prevention & mitigation strategies, for aircraft with skids (and an articulating boom):

- It is possible to have the two feet outside the cabin using a step designed for these types of operation.

**1.5.4.5 Pilot loss of visual reference**

Risk to be prevented: PIC loss of visual reference; HMD (helmet mounted display) information overload; focus on specific phase of flight relevant information by PIC (chime or gong).

Risk prevention & mitigation strategies:

- reduction of radio communication (temporary on hoist mission - info to ATC),
- crew Resource Management; example for off-shore harbor pilot transfer: during vessel hoist maneuver, PF only Intercom and hoist commands while PNF ATC and vessel communications.

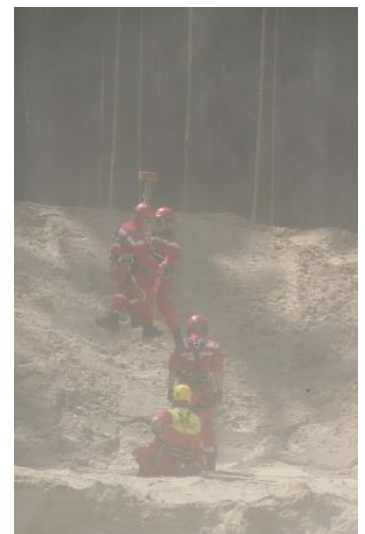
**1.5.4.6 Hoist maneuvers at night on shore**

Risk to be prevented: disorientation of the pilot, unstable positioning.

Risk prevention & mitigation strategies in an environment with limited visual reference for the flight crew (e.g. mountainous terrain with no light pollution - extreme darkness, snowing weather conditions, etc.):

- Configure helicopter autopilot in automatic mode of flight director position, hold/auto hover, where available.

#### 1.5.4.7 Hoist maneuvers at night off shore

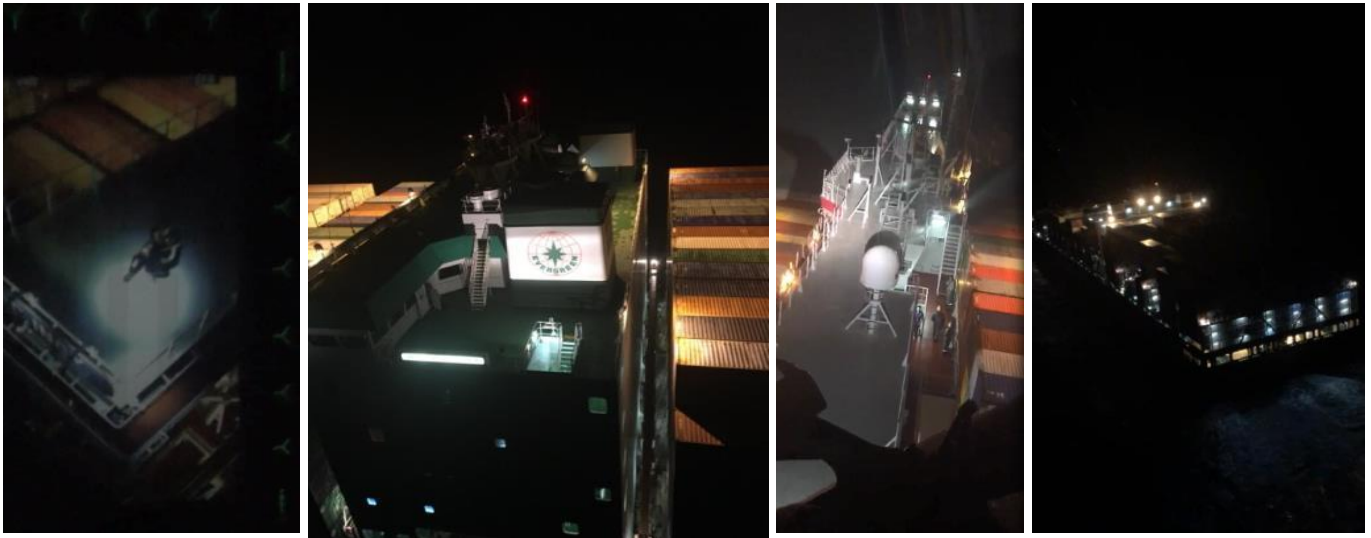

Risk to be prevented: disorientation of the pilot, unstable positioning.

Risk prevention & mitigation in extreme dark environment with limited visual reference for the flight crew (as off shore and only illumination of the vessel):

- Highly skilled and trained flight crew necessary, as helicopter autopilot in automatic mode of flight director position, attitude and altitude hold/auto hover is not able to use the ship as reference due to relative track & motion.

#### 1.5.4.8 Night Hoist operations white light vs. NVG

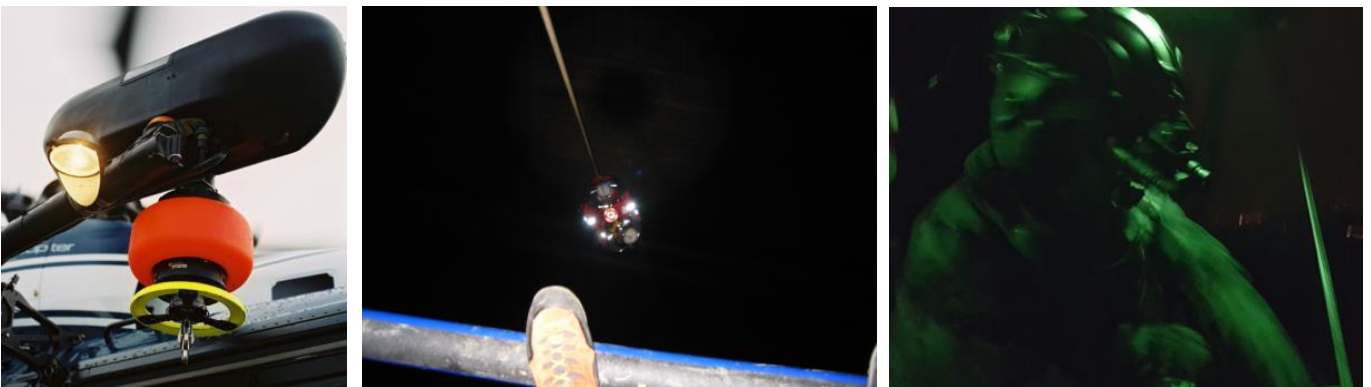

Risk to be prevented: insufficient ground scene illumination, rescuer on hoist is unable to see hand signals from the Hoist Operator due to the light beam under the fuselage.

Risk prevention & mitigation:

- most on-board search lights are not sufficient to illuminate the hoist mission area. Potentially a tactical high intensity light such as Trakka may be used to increase visibility for the helicopter crew,
- standardization of lighting signals to be introduced / developed for normal, abnormal and emergency procedures for hoist operations in case of loss of radio communication,
- hoist operations under NVG conditions - special training necessary and proficiency has to be demonstrated to remain current / mission ready

## 1.6 LESSONS LEARNT IN OPERATIONS: PROBLEM MANAGEMENT

### 1.6.1 HOIST NOT POSSIBLE TO REEL IN WITH HEC ATTACHED

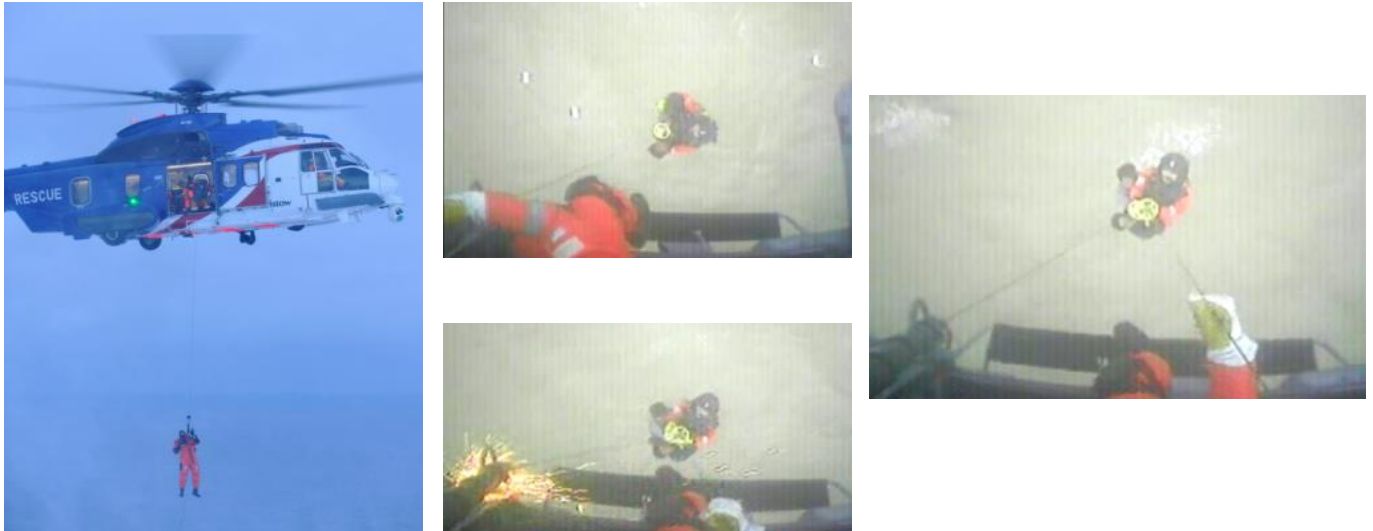

Risk to be prevented: hoist technical failure preventing reel-in of the HEC & crew not prepared/briefed for this incident.

Risk prevention & mitigation strategies:

- Crew briefing to address this type of emergency to be prepared in case of hoist failure / alternate plan / missed approach.

### 1.6.2 GROUNDING CABLE LOST IN OPERATION 1/2



Risk to be prevented: Grounding cable lost in operation due to incorrect sequence of attached hardware.

Risk prevention & mitigation strategies:

- the combination of used hardware and hook must match,
- appropriate hardware for this type of hook must be used.



**1.6.3 GROUNDING CABLE LOST IN OPERATION 2/2**

Risk to be prevented: Grounding cable lost in operation due to entanglement with ground structure.

Risk prevention & mitigation strategies:

- use of appropriate equipment (anti-static line without weight) to prevent entanglement,
- a predetermined breaking point shall exist.

**1.6.4 UNCONTROLLED ROTATION OF HEC ([LINK1](#) TO THE VIDEO) 1/2**

Risk to be prevented: Uncontrolled rotation of passenger during hoisting up leading to vertigo and even falling from height due to dizziness when set down in mountainous terrain (video [link2](#)).

Risk prevention & mitigation strategies:

- briefing & check of equipment: mostly vertical position, preferably put in front and not on back, with no heavy or large backpacks,
- increase of forward speed of HC as the critical cable length between 15 to 22 meters is to be avoided,
- brief on use of personal position ("Scheißhocke" or toilet position),
- finally, with faster hoist cable speeds, critical cable length can be passed faster/safer 6 hydraulic (slower 0,9 m/s) vs. electric (1,25 m/s) (faster).

**1.6.5 UNCONTROLLED ROTATION OF HEC ([LINK1](#) TO THE VIDEO) 2/2**



Risk to be prevented: Uncontrolled rotation of HEC during hoisting.

Risk prevention & mitigation strategies:

- In the situation where a stretcher procedure is needed, an anti-rotation line system should be used, or alternatively an aerodynamic type rudder (video [link](#)).

**1.6.6 BACKGROUND WIND NOISE IN INTERCOM**



Risk to be prevented: strong winds making hot mic of hoist operator and communication/commands hard to understand.

Risk prevention & mitigation:

- standard wording for commands,
- wind deflector or full face mask for intercom microphone.

## 1.7 TESTIMONY

SAR-Training

“Training for the unexpected”

“In the rescue-business it is important to note, that no matter how long a course, we can never train for every eventuality.

The training philosophy shouldn't be to give students a quick and shallow look at numerous scenarios, but to instill them into the basic skills which, combined with experience, can be used to solve every challenge they will encounter.”

Testimony of Klaus Hopf, Bavarian Police Helicopter Sqd.

## 1.8 LESSONS LEARNT IN OPERATIONS: TRAINING

### 1.8.1 NIGHT HOIST OPERATIONS TRAINING

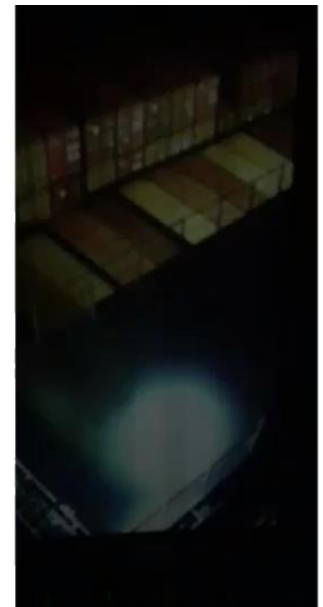

Risk to be prevented: inadequate skills, insufficient ground scene lighting.

Risk prevention & mitigation for night hoist operations:

- pilots and crew members need to be trained to constantly use manual techniques (hands on flying) and automatic mode (helicopter autopilot in automatic mode of flight director hold/auto hover),
  - radio communication between hoist operator/flight crew and hoist passenger/ground crew is mandatory, as hoist passenger/ground crew may not be able to see hoist operator when searchlights from helicopter illuminate the scene
- 6 may be different for off-shore harbor pilot transfers, when vessel is illuminated.

**1.8.2 TRAINING - THEORETICAL AND OPERATIONAL 1/2**

Risk to be prevented: training insufficiently documented.

Risk prevention & mitigation:

- hoist operator basic requirements / assessment / qualification / certification → AOC to reflect qualification procedure / syllabus.
- initial, Proficiency / recurrent check concept NORM & EMERG procedures → informational briefing of FLM, regulations, organizational, equipment, etc. changes (classroom & operational tasks).

**1.8.3 TRAINING - THEORETICAL AND OPERATIONAL 2/2**

Risk to be prevented: loss over time of skills & procedure knowledge.

Risk prevention & mitigation:

- Annual proficiency / recurrent check concept NORM & EMERG procedures → informational briefing of FLM, regulations, organizational, equipment, etc. changes (classroom & operational tasks).

#### 1.8.4 EMERGENCY TRAINING CONCEPT



Risk to be prevented: insufficient emergency procedures knowledge or coordination.

Risk prevention & mitigation:

- emergency training concept, all EMERGENCY scenarios to be trained under real conditions, e.g. OEI training → awareness of potential risks such as height loss, pendulum, loss of intercom & radio etc. and to be performed under “safe” conditions,
- training objectives should include A/C performance (OEI consideration), action in case of fly away, etc.,
- operators with multiple platforms and potential risk of lack of knowledge or familiarity of control panel location in cabin,
- training concept of pilot and hoist operator training / combined (at the same time) not ideal, as two newcomers are trained at the same time → mitigation by splitting the trainings.

#### 1.8.5 NORMAL PROCEDURE TRAINING WITH HEC



Risk to be prevented: normal operations training not relevant.

**Risk prevention & mitigation:**

- normal procedures must also be trained with trained human cargo (personnel) to ensure situational awareness of the hoist operator,
- pilots must experience being hoisted (not as a pilot) to improve many aspects of the hoist operations including crew coordination,
- rescue dogs shall wear a muzzle or dog biting protection.

**1.8.6 TRAINING OF CABLE SLACK MANAGEMENT**

Risk to be prevented: helicopter pulling on hoist cable attached to ground.

**Risk prevention & mitigation:**

- Promote the management of cable slack during training. The Hoist Operator must be trained on how to manage the quantity of cable reeling out/in when load may be attached to the ground or the hook lowered to a rolling / unsteady target / ship.

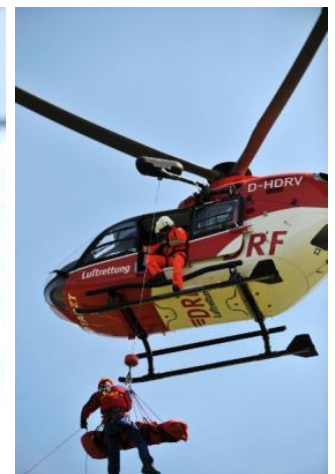
**1.8.7 TRAINING COOPERATION OF VARIOUS HOIST OPERATORS/ORGANIZATIONS**

Risk to be prevented: inefficient interaction with third parties.

**Risk prevention & mitigation:**

- Training cooperation of various hoist operators/organizations with rescuers/ground forces with the hoist to work together and apply standardized procedures.

### 1.8.8 RECURRENCE TRAINING ON SYNTHETIC FLIGHT TRAINER

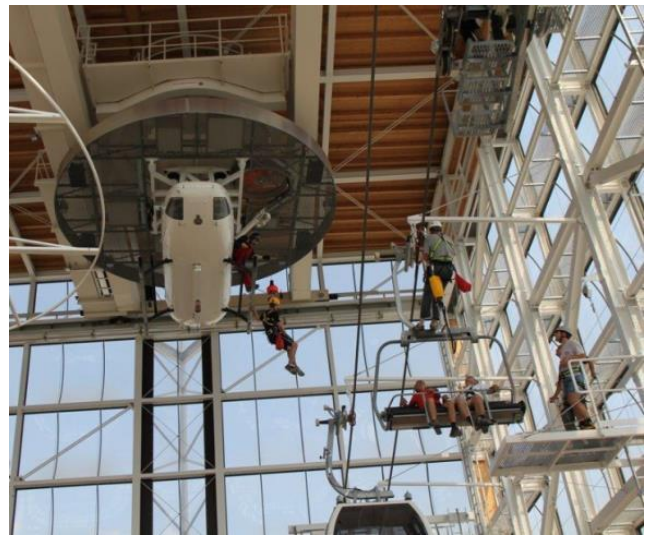

Risk to be prevented: incidents during training on real conditions.

Risk prevention & mitigation:

- Annual recurrence training: crew to receive training in simulator or similar device to reproduce various kinds of emergencies.

### 1.8.9 DRY GROUND PCDS / PSE TRAINING



Risk to be prevented: lack of currency.

Risk prevention & mitigation:

- Perform frequent ground training refreshment and brief for hoist operators and rescuers.

## 1.9 LESSONS LEARNT IN OPERATIONS: IT & MAINTENANCE

The following lessons learnt come from actual events analyzed by the ESPN-R task force.

### 1.9.1 TRACKING OF HELICOPTER CONFIGURATION IN IT SYSTEM



Risk to be prevented: incorrect helicopter configuration in IT system, inappropriate planning or cancellation of mission.

Risk prevention & mitigation strategies:

- Deploy robust processes for helicopter configuration tracking.

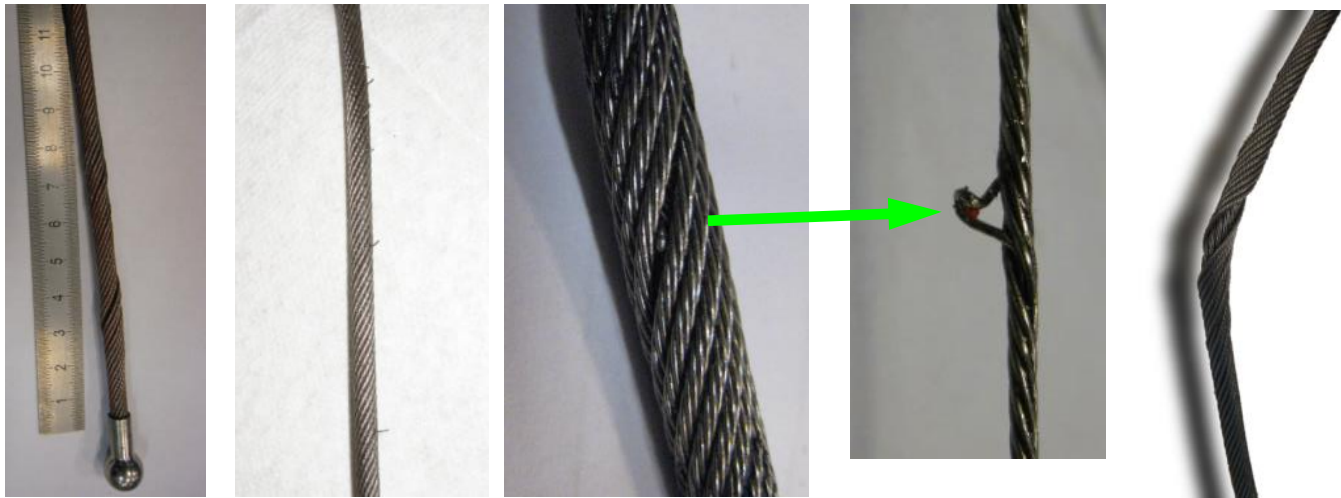

**1.9.2 CABLE DAMAGES DURING HOIST OPERATION**

Birdcaging

Severe abrasion

Shock load

Kink



Cable miswrap

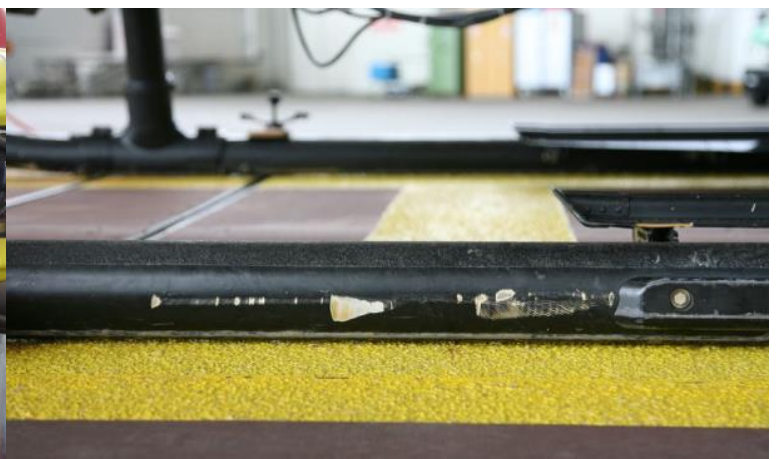

Cable chafing on landing gear skid tube

Risk to be prevented: damage to hoist cable during operations, damage non-detection by maintenance technician.

Risk prevention & mitigation:

- training of hoist operators for hoist cable damages during hoist operation to avoid a potential loss of load and substantial damage to the equipment,
- sharing information with maintenance technicians on damage typologies.

**1.9.3 MAINTENANCE PROCEDURES NOT APPLIED AS PER DOCUMENTATION**

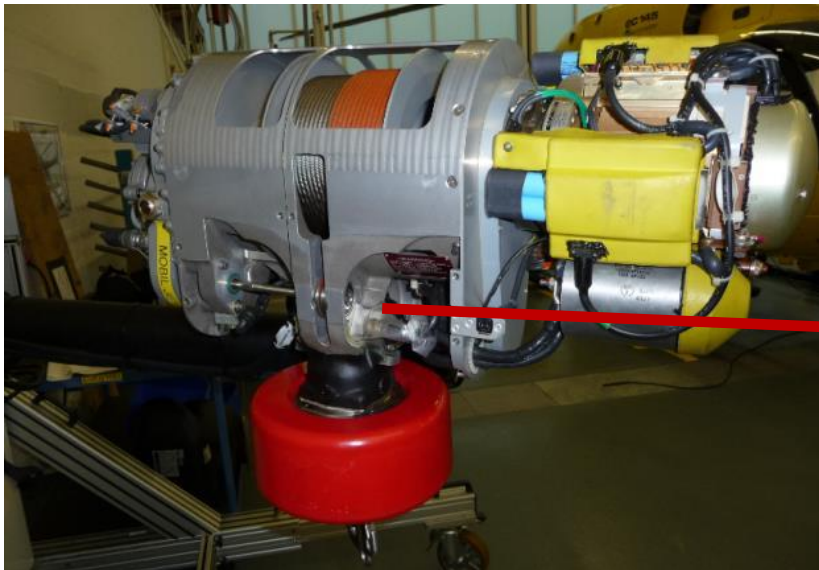

Risk to be prevented: Maintenance procedures not correctly applied (for instance pyrotechnic cartridge not installed).

Risk prevention & mitigation strategies:

- dual inspection to be performed,
- apply the same safety, quality, training, tools, etc. to hoist maintenance as when working on similarly critical components (main rotor blades, engines, etc.).

**1.9.4 CRITICAL TASKS / MAINTENANCE PROCEDURES IN THE HOIST LOAD PATH**

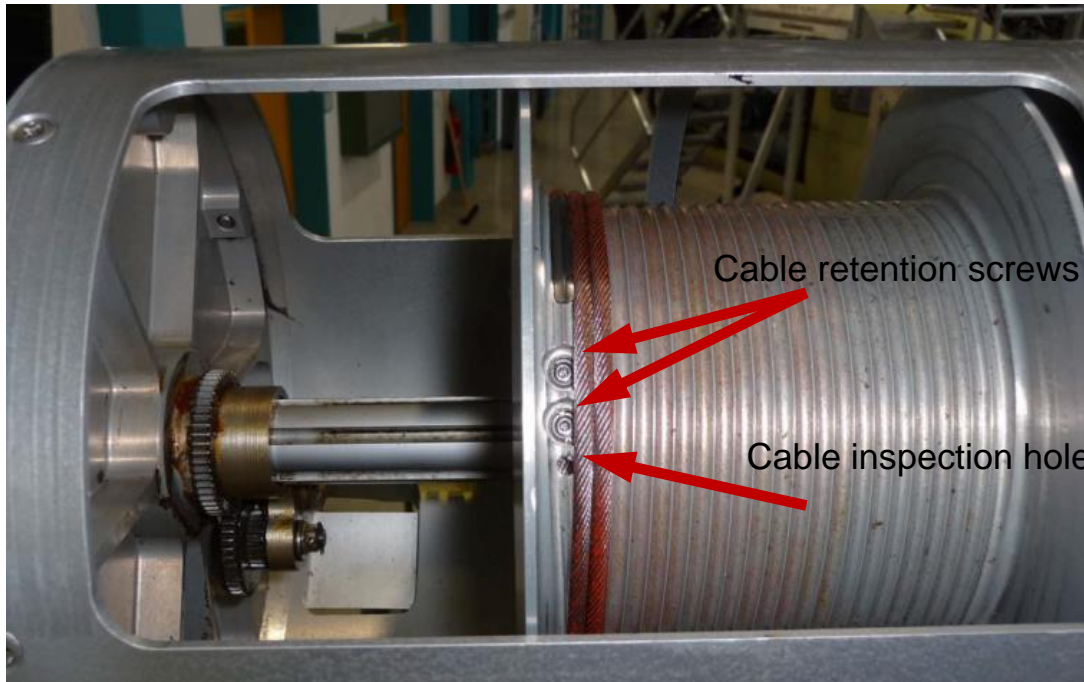

Risk to be prevented: Maintenance procedures not correctly applied.

Risk prevention & mitigation strategies:

- Critical tasks during servicing / maintenance / repair to be performed with four eye principle, e.g. hoist cable change, micro-switch setting, etc.

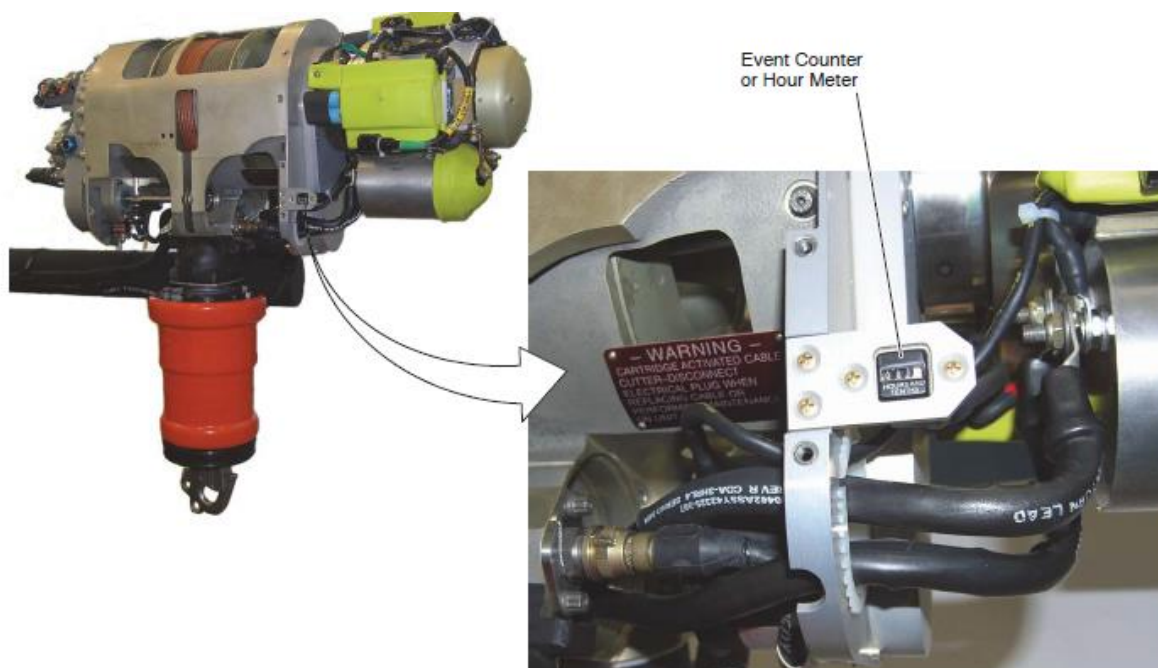
**1.9.5 HOIST USAGE (HRS / CYCLES) INFORMATION NOT CORRECTLY TRACKED**

Risk to be prevented: Hoist usage (hrs / cycles) information not well monitored by flight crew, maintenance staff and not correctly tracked in the IT system leading to maintenance procedures not correctly applied, unairworthy hoist.

Risk prevention & mitigation strategies:

- Stick to procedures & processes for hoist usage monitoring.

**1.9.6 HOIST MAINTENANCE TRAINING**

Risk to be prevented: Lack of currency on maintenance & operation procedures.

Risk prevention & mitigation strategies:

- Recommendation to National Aeronautic Authorities to make the recurring training mandatory.

**1.9.7 AWARENESS OF APPROVED CONFIGURATION OF SUB SYSTEMS**

FIG. ITEM NO.	PART NUMBER	AIRLINE STOCK NUMBER	NOMENCLATURE	EFF CODE	UNITS PER ASSY
PLT					
R -1	44301-1-1		HOIST SYSTEM, EXTERNAL MOUNTED (EC135)	A	RF
R -1A	44301-1-2		HOIST SYSTEM, EXTERNAL MOUNTED (BK117C2BK117D2)	B	RF
R -1B	44301-1-3		HOIST SYSTEM, EXTERNAL MOUNTED (EC135)	C	RF
R -1C	44301-1-4		HOIST SYSTEM, EXTERNAL MOUNTED (EC135)	D	RF
R -1D	44301-1-5		HOIST SYSTEM, EXTERNAL MOUNTED (BK117C2BK117D2)	E	RF
R -1E	44301-1-12		HOIST SYSTEM, EXTERNAL MOUNTED (EC135)	F	RF
R -1F	44301-1-14		HOIST SYSTEM, EXTERNAL MOUNTED (EC135)	G	RF
R -1G	44301-1-10		HOIST SYSTEM, EXTERNAL MOUNTED (BK117C2BK117D2)	H	RF
R -1H	44301-1-11		HOIST SYSTEM, EXTERNAL MOUNTED (BK117C2BK117D2)	J	RF
R -1J	44301-1-15		HOIST SYSTEM, EXTERNAL MOUNTED (EC135)	K	RF
R -1K	44301-1-17		HOIST SYSTEM, EXTERNAL MOUNTED (EC135)	L	RF
R -1L	44301-1-18		HOIST SYSTEM, EXTERNAL MOUNTED (EC135)	M	RF
R 5	44301-700		JUNCTION BOX ASSEMBLY (PRE-SB 44301-700-05)		1
R -5A	44301-700-1		JUNCTION BOX ASSEMBLY (POST-SB 44301-700-05)		1
R 10	44301-720		CONTROL PENDANT ASSEMBLY	A-G, K, L, M	1
R -10A	44301-721		CONTROL PENDANT ASSEMBLY	H, J	1
R 11	102-STD-A		.. LENS, AMBER (D51) (V08717) (USE WITH ITEM 10 ONLY)	A-G, K, L, M	1
R 12	102-STD-R		.. LENS, RED (D52) (V08717) (USE WITH ITEM 10 ONLY)	A-G, K, L, M	1
R 13	FB59		.. LAMP (V08717) (USE WITH ITEM 10 ONLY)	A-G, K, L, M	2
R 15	44301-500		BOOM AND SUPPORT ASSEMBLY	A	1
ITEM NOT ILLUSTRATED					

Risk to be prevented: In Flight use of unapproved hoist configuration.

Risk prevention & mitigation strategies:

- If unsure ask your Techrep or OEM for clarification.

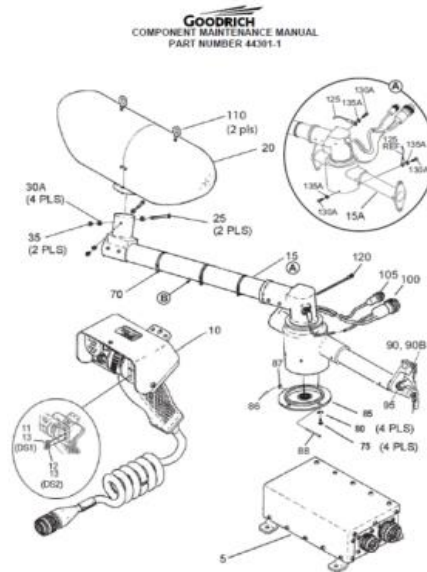
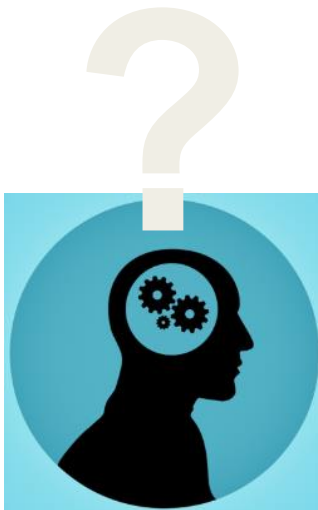
**1.9.8 HOIST TOOLS AND GROUND SUPPORT EQUIPMENT**

Risk to be prevented: Incorrect maintenance procedure application.

Risk prevention & mitigation strategies:

- Dedicated ground support equipment shall be available by the OEM to ensure correct application of maintenance procedures.

**1.9.9 SPARES, TECHNICAL SUPPORT AND MRO**

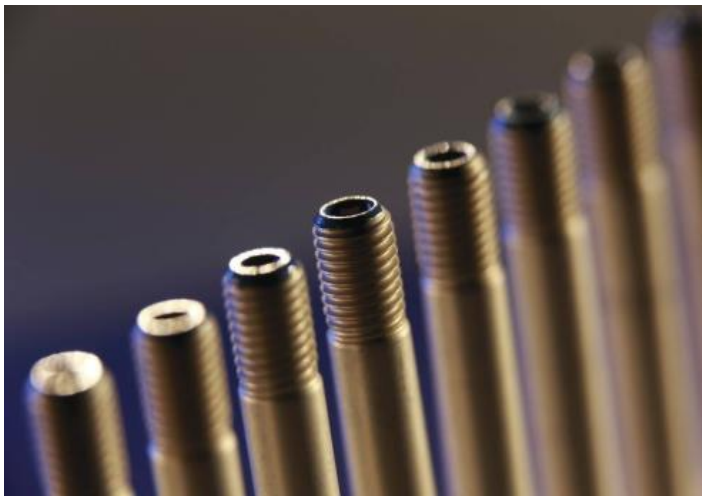

Risk to be prevented: Hoist equipment unserviceable.

Risk prevention & mitigation strategies, OEMs shall have an outstanding AOG spares service:

- Technical & logistical single point of contact,
- high industry quality standard,
- reliable / fixed turnaround times,
- rental / exchange units pool,
- for operators starting the hoist operation, OEMs shall make a minimum spares kit available.

## 2. AIRBUS HELICOPTERS ADDITIONAL NOTES

### 2.1 SUPPORTING MODIFICATIONS

Some technological modifications can bring substantial operational benefits for hoist operations.

#### 2.1.1 LIGHTING FOR HOIST OPERATIONS

Developments from Airbus Helicopters have shown that while a hoist beam mounted light can bring better visibility on the hoist passenger, it provides little height perception and can depending on setup be obstructed by the hoist operator's body.

Lighting coming from the side at an angle allows a better perceiving of the height of the hoist passenger. Typically, these can be implemented with swivelling lights or less expensively with fixed lights (adjustable only on the ground) on the tail boom.

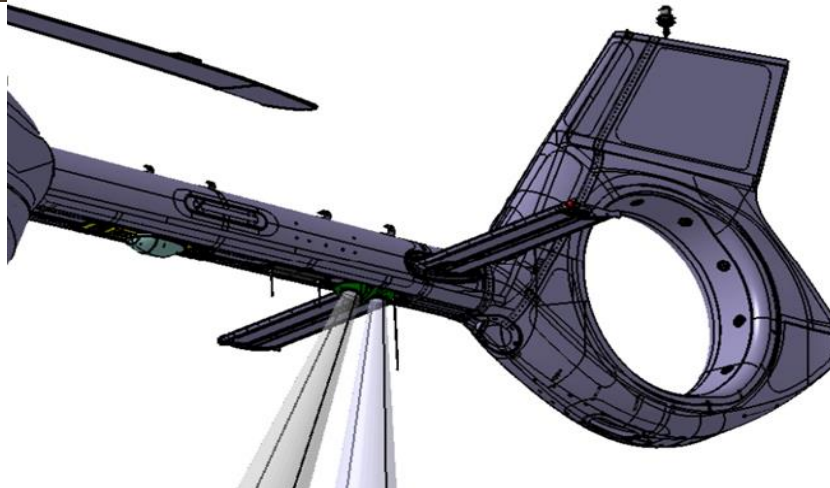

Depending on the aircraft, a fixed light setup (adjustable only on ground) can be affected by the evolution of the center of gravity in flight. It will also have "blind spots" along the length of the cable. The adjustments will have to focus on the mission's most critical phases.

### 2.1.2 CAMERA FEED FOR HOIST OPERATIONS

Similarly, live feeds from hoist beam mounted cameras can provide benefits for the crew's situational awareness. A tail boom mounted camera linked to the glass cockpit display can provide interesting situation awareness benefits for rotor-turning embarkation as well as some phases of hoisting. A hoist beam mounted camera linked to the cockpit glass display can be a useful back-up for the pilot's situation awareness.

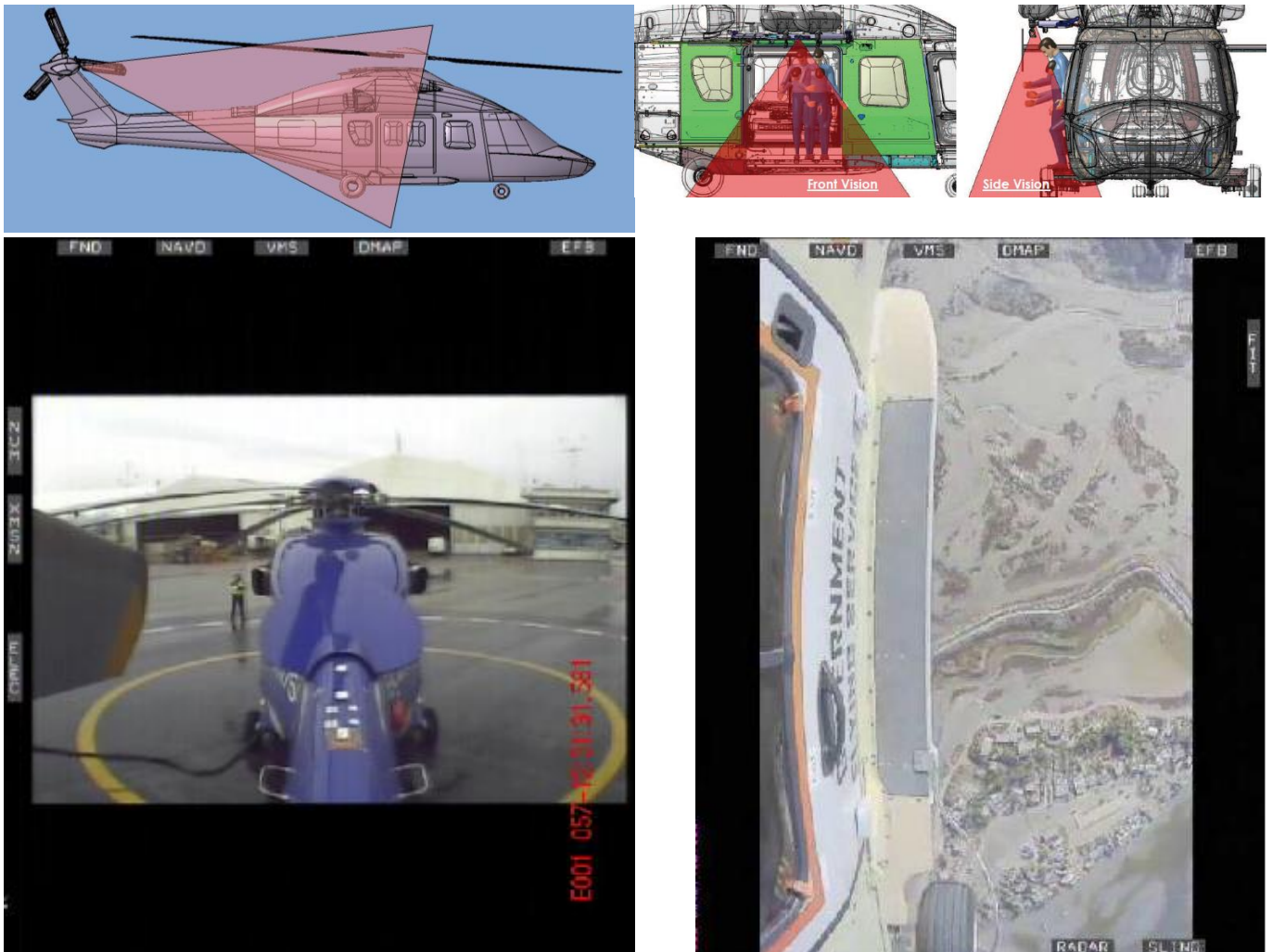



### 2.1.3 RECOMMENDED PRACTICES FOR OPTIMAL USE OF PCDS

Recommended practices for rescue harness use:



The rescue harness must be attached to the hoist hook before down-hoisting



During down-hoisting the rescuer will unfold the rescue harness



When arriving at the patient the rescuer closes the rescue sling and tightens it firmly



When the rotation lock system on the rescue harness is closed and adjusted, the up-hoisting can start after signaling

In addition to sections 1.3.1.1, 1.3.1.2 and 1.3.1.3:

- Comply with your authority's PCDS certification requirements if existing (technical solutions available as STC or via Airbus Helicopters on request),
- Use mission-type-adapted PCDS,
- Set your own mission-type specific operational standard; make sure that it fits to each operator and that it is easy to use before entering into operation,
- Regularly check proper condition and potential exceeding of time change items, for instance incorporate the condition check of your PCDS in briefings and debriefings,
- Provide rescuers and operators with initial and recurrent training so that they are familiar with the type of equipment to be used (and information on the respective attachment points in the helicopter),
- Before using a PCDS, make sure that it fits the body size of the person that will wear it (person to be rescued),
- Include in your checklist a PCDS inspection after having geared up; ideally a 4-eyes check (or "buddy check") or at least as a self-performed "double check",
- Provide trainings to crew, hoist operators and relevant third parties on communication (method, phraseology and signals),
- It is recommended to engage first the rescue harness in the hook and only then the rescuer's harness. This limits the risk of the rescue harness getting out of the hook and it also allows the rescuer to quickly disengage from the hook.

## 2.2 OPERATIONAL RECOMMENDED PRACTICES

Depending on whether the hoisting operations are performed by night or during the day, onshore or offshore, specific recommended practices & scenarios can be identified.

### 2.2.1 OFFSHORE HOISTING OPERATIONS

One of the specifics of offshore flight is usually laminar wind conditions. However, with the increasing use of large tankers or cruisers, specific risks need to be tackled.

#### 2.2.1.1 Operating close to large vessels: 1 Cliff effect

Large vessels are an obstacle to laminar winds at sea and can generate dynamic updrafts and vortices, much like what can be encountered in mountain flying.

Risk identified: quick variations of dynamic updraft due to ship heading change or squalls from a different direction can induce significant height gain or loss.

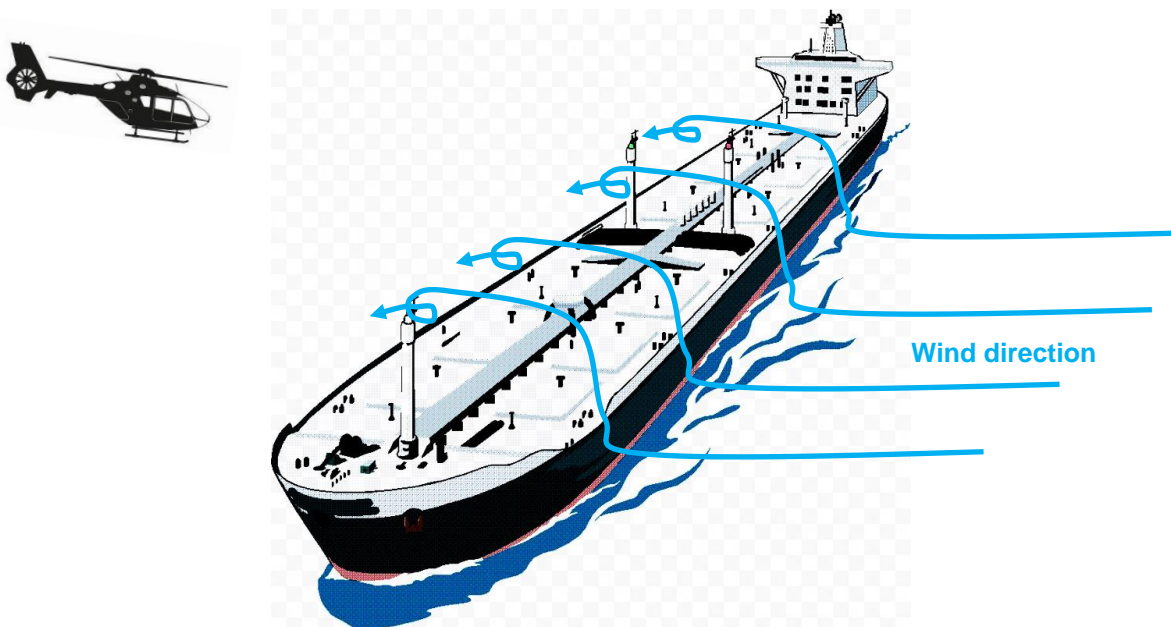

Mitigation: strong awareness to this effect must be maintained

- by the pilot for choosing the hovering area, approach vector and the risk caused by obstacles in case of downdraft,
- by the hoist operator, to make sure that height variations do not occur with a hoist passenger close to the ship.

**2.2.1.2 Operating close to large vessels: 2 Swing back effect**

Large obstacles windward will “mask” the wind from the hoist passenger at some point on the way down.

Risk identified: No longer pushed by the wind, the hoist passenger will swing back to a position vertically below the helicopter.

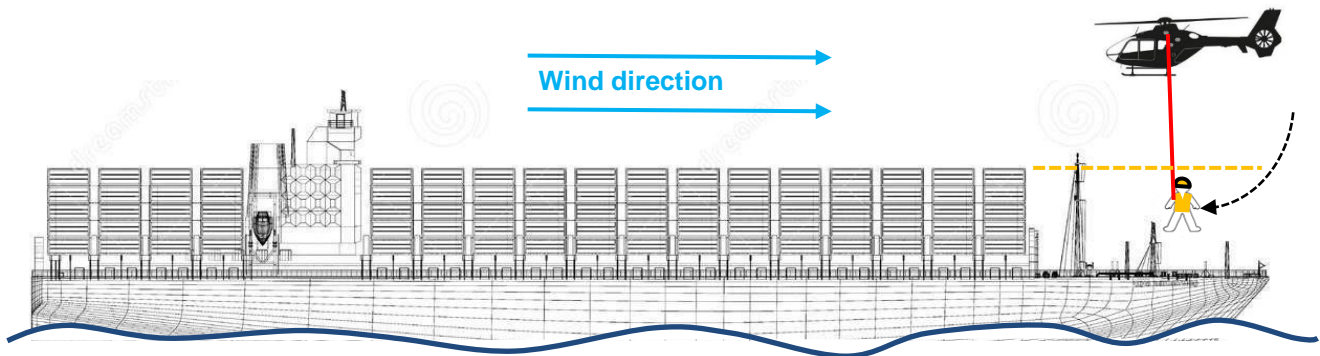
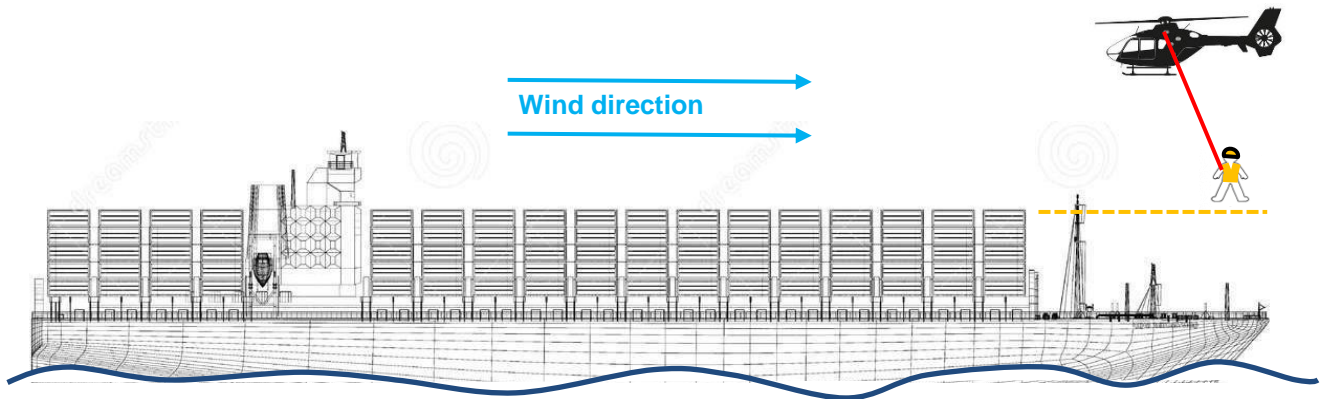

Risk mitigation: the hoist operator needs to anticipate this effect and adapt the approach vector and cable reeling speed accordingly.

### 2.2.1.3 Operating close to large vessels: 3 Smoke

Large vessels may emit smoke from their engine stacks. Depending on ship heading, wind direction, this can generate a risk if the smoke trail is in the aircraft approach path.

Risk identified: risk to negatively impact engine performance, including and up to uncommanded in-flight engine shutdown; also a medium term risk of engine contamination build-up.



Risk mitigation: it is possible to assess whether the aircraft is on the smoke trail by day (by sight) as well as by night (by smell).

- By day, the crew can assess the possibility to adapt the approach depending on wind direction and obstacles.
- By night, or if changing the approach is not practical by day, the crew should abort the approach and call for the ship captain to change the ship heading, then reposition to initiate a new approach.

### 2.2.1.4 Offshore Navigation to join large vessels

Risk identified: going to the wrong ship by night or during missions with drops to several ships, loss of visual reference if encountering fog banks in VFR.

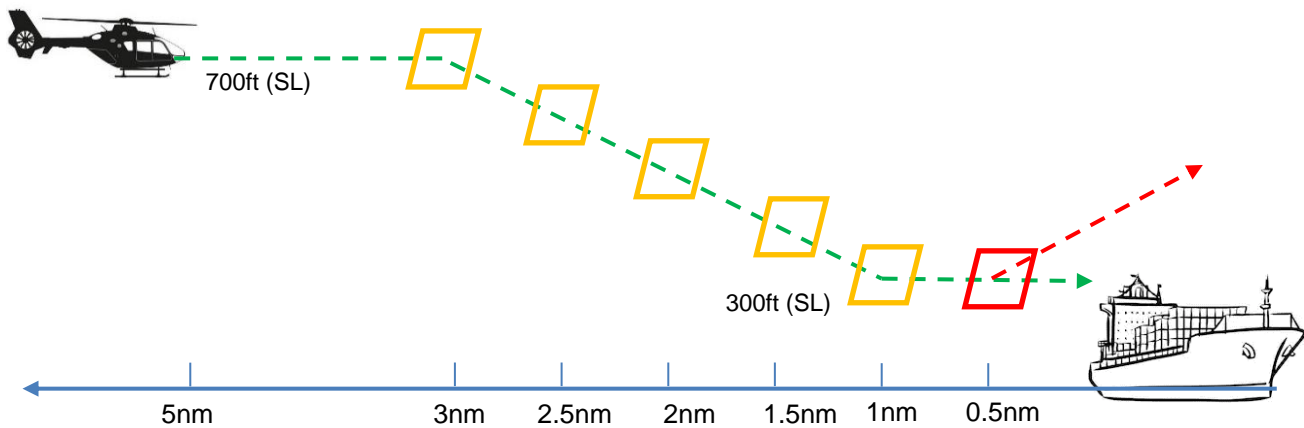

Risk mitigation: For offshore environments (no obstacles), a specific approach can be set up where a crew member will call out the height and distance to the ship to the pilot at pre-defined intervals to establish a stabilized approach. At 0.5nm from the target ship, if the ship is not visible then the approach is aborted and a go around will be performed.

Homing on the ship can be assisted:

- Using the ARA procedure (airborne radar approach), which repurposes some weather radars to detect the ship mass.
- Or using the AIS, equipment using the ship transponder information.

Note: It is recommended to use this structured approach even in VFR with good visibility. To make this a standard practice, allow the crew to remain up to date on the procedure and avoid disorientation in case of I-IMC (inadvertent entry into instrument meteorological conditions).

### 2.2.1.5 Operating close to small vessels: downwash

Small vessels can be strongly affected by the downwash of a helicopter.

Risk identified: Small boats may be pushed away by the rotor downwash thus creating an unstable approach needing constant adjustments and creating the risk of the pilot losing sight of the boat. There is also a risk of creating a pendulum movement for the hoist passenger if the pilot follows the boat movement instead of following a smooth trajectory.

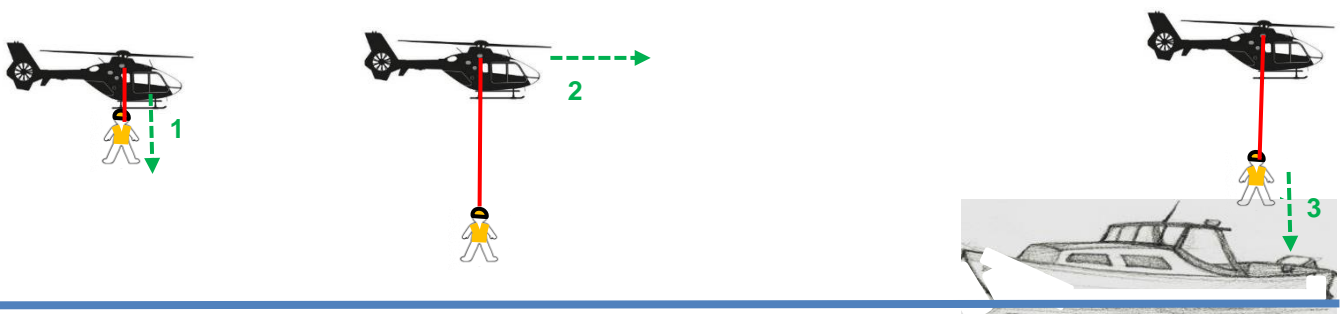

Risk mitigation: a specific approach can be defined where the hoist passenger is lowered to 6 feet from sea level away from the boat. The pilot will finish the approach and then the hoist operator finishes lowering the hoist passenger. This procedure implies a risk of dragging the hoist passenger in the water: maintaining height is thus essential.

### 2.2.1.6 Helicopter static electricity

Specific environmental conditions (e.g. storm, snow, dust) can induce increased static electrical loads on the aircraft.

Risk identified: It is important that the hoist passenger does not come into contact with the ground (or boat) before the bonding cable makes contact.

Risk mitigation:

- brief the hoist passenger to maintain the bonding cable straight with his shoes. This will prevent the cable from being deflected by the wind.
- Pay attention to the hoist passenger height and make sure that the bonding cable provides sufficient margin.
- Brief hoist passengers not to “guide” the cable reeling-up by holding the grounding cable, as they can end up completing the grounding loop with their body.

Note: be careful if you put a weight at the end of the bonding cable. While it makes it less prone to wind deflection, it creates a risk it will lash onto the pad environment as a bolas would, it also increases the risk of airframe damage.

## 2.2.2 ONSHORE HOISTING OPERATIONS

One of the specifics of on-shore hoisting operations is that ground obstacles and hills frequently induce non laminar wind and vortices.

### 2.2.2.1 Evaluation of the operation area

Risk identified: non identified perturbations and obstacles can lead to aircraft damage and hoist passenger injury.

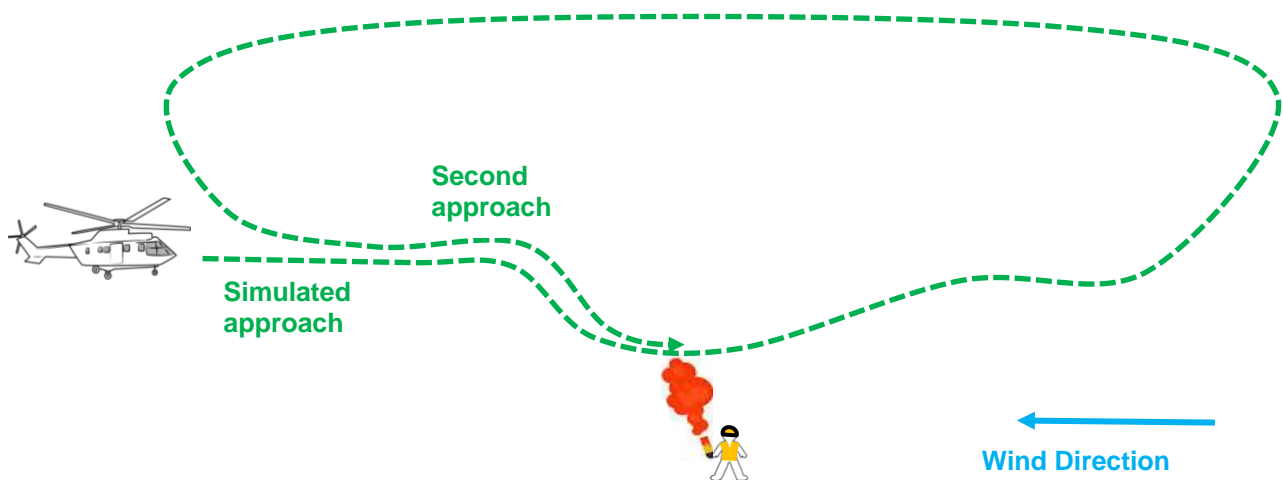

Risk mitigation:

- If there is no specific urgency, always take the time to first simulate an approach and perform a go around. This can help set the navigation system reference point, and check common understanding of the crew on the intended operation area. Also see section 1.5.3.1.
- To determine local aerological conditions, the ground crew can deploy smoke canisters (paying attention to fire hazards in case of dry conditions). If there is no ground crew, the simulated approach is a good opportunity to drop the smoke canister on the intended operation area from the aircraft.

### 2.2.2.2 Operation area with reduced accessibility

It is generally preferable to have the person to be hoisted come below the helicopter, when the environment is not confined. On the contrary, when the environment is confined, it is preferable that the person to be hoisted stands still in a chosen favorable spot.

Risk identified: environment with a lot of obstacles

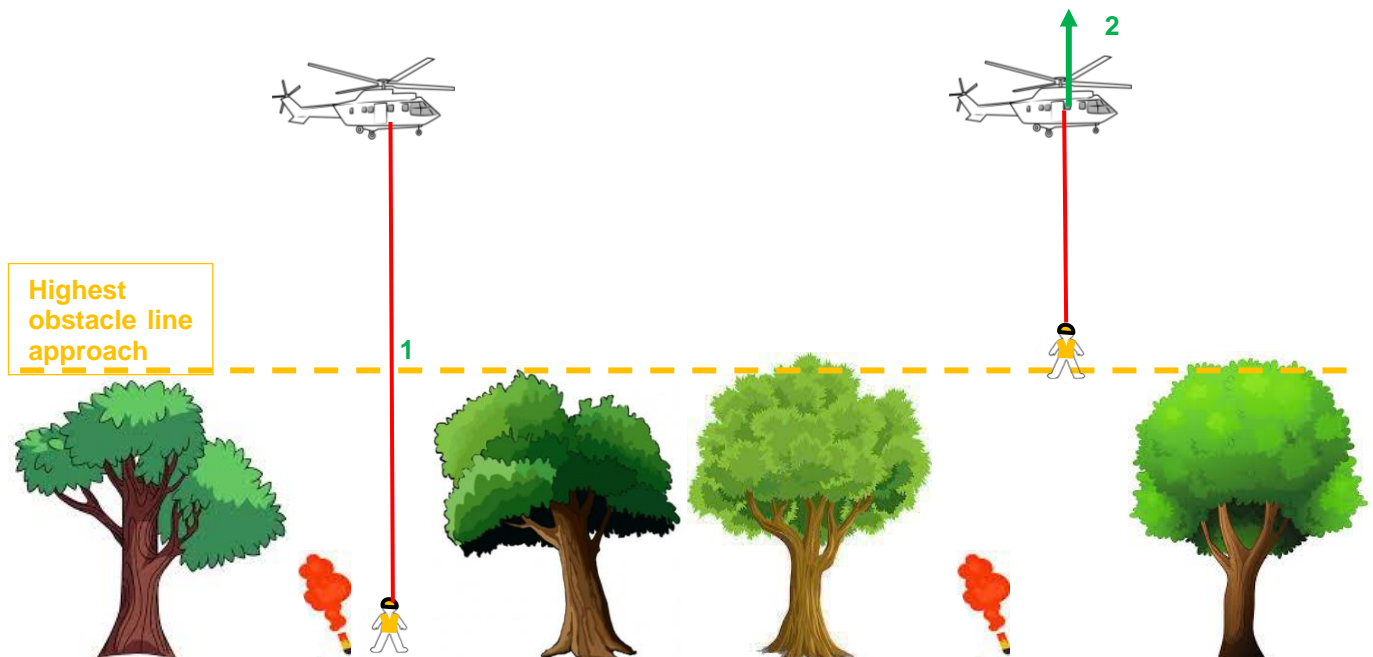

Risk mitigation:

- Prioritize minimizing risk exposure time.
- A specific approach can be defined where, when the hoist passenger is above the highest obstacle, the helicopter will start to climb as the cable is being reeled-in. Gaining height is preferable to the helicopter initiating forward speed as climbing allows to keep a better sight on the hoist passenger and makes it slightly easier to embark.

### 2.2.3 NIGHT OPERATIONS

Risk: If no hoist beam or tail boom mounted light or swivelling light is available, lack of visibility for people on the ground and the hoist operator can lead to injuries.

Risk mitigation: it is recommended to attach lightsticks to the hoist hook to increase visibility for people on the ground and the hoist operator.

## 2.2.4 GENERAL RECOMMENDED PRACTICES

Recommended Practice 1: Brief hoist passengers to look at the hoist operator in all circumstances.

Recommended Practice 2: When the hook is going up or down close to the hoist passenger on the ground, there is a risk that the hook hits the hoist passenger on the head as the cable slack decreases. As a risk mitigation it is recommended to keep the hook at a distance shielding oneself with the forearm. Consider the use of a helmet.

Recommended Practice 3: Develop and use a standard phraseology for crew communication that is resistant to partial transmission (ex: "positive", "negative", can both return partial as "\*\*\*\*ive"). Complexity of this standard should be kept consistent with the frequency of use of the target population.

Recommended Practice 4: Crew communication: Read-back messages, i.e. repeat the messages you receive or an appropriate part thereof to the sender so as to obtain confirmation of correct reception and give the sender the opportunity to repeat or correct the messages.

Recommended Practice 5: Continuous improvement: Operators should look out for new and improved equipment on the market. There are constantly new developments for supporting aids and products, for instance (but not exhaustive):

- new protective gloves with special features, i.e. with special fabrics for abrasive and puncture protection especially taking into account the needs of a hoist operator,
- fall-dampers on PCDS,
- strap cutting devices,
- etc