

**SUBJECT: ENLARGED VERTICAL REFERENCE WINDOW
 (P/N 350-201154 and 355-201154)**

The Enlarged Vertical Reference Window is mounted in the floor of the aircraft with a corresponding window in the belly panel. The enlarged window provides better pilot reference, for long line operations.

APPLICABILITY:

This Flight Manual Supplement shall be used when the Enlarged Vertical Reference Window is installed on the helicopter.

Department of Transport
 (Canada) Approved



G. David
 Senior Engineer, Aircraft Certification
 Aircraft Certification (PAI)
 Ontario Region

IMPORTANT NOTE

THE INFORMATION AND DATA CONTAINED IN THIS DOCUMENT SUPERSEDE OR SUPPLEMENT THAT CONTAINED IN THE BASIC APPROVED FLIGHT MANUAL FOR THE AS 350 OR AS 355 HELICOPTER IN THOSE AREAS LISTED HEREIN. FOR LIMITATIONS, PROCEDURES AND PERFORMANCE NOT CONTAINED IN THIS DOCUMENT REFER TO THE APPROVED FLIGHT MANUAL AND OTHER APPLICABLE APPROVED FLIGHT MANUAL SUPPLEMENTS.

SECTIONS 2, 3, 4 AND 5 OF THIS DOCUMENT COMPRISE THE APPROVED FLIGHT MANUAL SUPPLEMENT. COMPLIANCE WITH SECTION 2, LIMITATIONS, IS MANDATORY.

SECTIONS 1 AND 6 ARE UNAPPROVED AND ARE PROVIDED FOR INFORMATION ONLY.

THE INFORMATION CONTAINED IN THIS DOCUMENT SHALL BE TREATED AS THE PROPERTY OF AIRBUS HELICOPTERS CANADA LIMITED (AHCA). THE RECIPIENT OF THIS DOCUMENT SHALL NOT DISCLOSE ANY INFORMATION CONTAINED HEREIN TO THIRD PARTIES WITHOUT THE WRITTEN PERMISSION OF AHCA, AND SHALL NOT USE OR REPRODUCE THIS DOCUMENT IN WHOLE OR IN PART FOR ANY PURPOSE OTHER THAN ITS ORIGINALLY INTENDED PURPOSE, OR TO EVALUATE ITS CONTENTS.

	NAME AND SIGNATURE	DATE	COMPANY DEPARTMENT
PREPARED BY:	D. Kerr <i>DK</i>	12 Jan, 2015	AHCA ENGINEERING
PREPARED BY:			
CHECKED BY:	G. Krebs <i>[Signature]</i>	Jan 10, 2015	AHCA CHIEF TEST PILOT
CHECKED BY:	C. Timmins <i>C. Timmins</i>	12 th Jan 2015	AHCA ENGINEERING
REV 4 APP'D/ACCEPTED (Civil A/W Authority)			TCCA
REV 4 RELEASED BY:	P. Sharpe <i>[Signature]</i>	28 Jan 2015	AHCA ENGINEERING



AIRBUS HELICOPTERS CANADA LIMITED

RECORD OF REVISIONS

Rev.	Pages at this revision	Description, Reason, Changed Pages	Prepared (name and date)	Checked (name and date)	App'd/Acc'd (Civil A/W Authority) (name and date)	Released (name and date)
0	1 through 10	Original Issue	D. Kerr 22 Feb. 2006	R. Manson 22 Feb. 2006	TCCA J. Palmer 5 April 2006	R. Manson 6 April 2006
1	1 through 10	Revised to incorporate installation for the AS 355, description updated (Pages 4 to 6, 8 and 9)	D. Kerr 24 April 2006	G. Krebs 24 April 2006	TCCA J. Palmer 13 June 2006	R. Manson 13 July 2006
2	1 through 12	Revised P/N. Torque Select Switch name corrected. Placards revised depending on Instrument panel type. (Pages 3 to 11)	D. Kerr 16 July 2008	G. Krebs 17 July 2008	N/A	C. Timmins 6 May 2013
3	1 through 14	Revision to Figure 1 showing relocation of load meter with 50A / Longline/Carousel System and fire extinguisher relocation. Location description of placards revised. (Pages 3 to 5, 8 to 10)	D. Kerr 5 February 2014	G. Krebs 9 February 2014	TCCA G. David 23 July 2014	P. Sharpe 1 August 2014
4	1 through 14	Revision to incorporate the fire extinguisher relocation with the two-place front seat. (Pages 4, 5 & 8)	See page 1.	See page 1.	See page 1.	See page 1.

NOTE: Revisions to this document will be distributed to operators of this equipment by the STC holder.
NOTE: Revised portions of affected pages are identified by a vertical black line in the margin adjacent to the change.
NOTE: Minor changes are released in accordance with TCCA - ACCEPTED CAR 521.154 procedures (ref. DAPM-E-0001)

Transport Canada Approved

TC Approved
JAN 23 2015



AIRBUS HELICOPTERS CANADA LIMITED

FLIGHT MANUAL SUPPLEMENT
ENLARGED VERTICAL REFERENCE
WINDOW
AS 350 / AS 355

CONTENTS

SECTION	TITLE	PAGE
1	GENERAL	4
2	LIMITATIONS	9
3	EMERGENCY PROCEDURES	10
4	NORMAL PROCEDURES	10
5	PERFORMANCE DATA	13
6	WEIGHT AND BALANCE	14

FIGURES

FIGURE	TITLE	PAGE
1	General Layout	5
2	Switch and Annunciator locations for Torque Indicator Option	6
3	Switch and Annunciator locations for Torque Indicator Option (continued)	7
4	Torque Select Switch locations on the Instrument Panel	11
5	Torque Select Switch locations on the Instrument Panel (continued)	12
6	Press to Test Button on the Instrument Panel	13

Transport Canada Approved

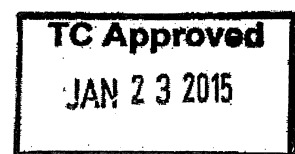

1. GENERAL (unapproved)

The Enlarged Vertical Reference Window is an optional window for the AS350/AS355 mounted in the floor of the aircraft, just outboard of the pilot's seat, with a corresponding window in the belly panel. The enlarged window provides better pilot reference, as in long line operations.

The belly panel window extends back beyond the aft edge of the lower front fairing. An extension is attached to the back of this fairing, on the right hand side. The front of the intermediate fairing is trimmed back by a similar amount. The landing light, which is located on the right hand side of the intermediate fairing, is relocated lower and aft, to clear the enlarged window. Provisions for the light are included in the modifications to the intermediate panel.

This installation includes an option for a second torque indicator (AS 350 B2 without VEMD only), located where it is visible through the floor window. This allows the pilot to monitor the torque during long line operations. It is activated using a switch on the instrument panel, with selection for either the floor or panel mounted indicator. A green annunciator light on the instrument panel indicates that the floor window indicator is selected.

For AS 350 B2/B3 that embody the 50A/Longline/Carousel System, which relocates the load meter to the floor window area. The longline switches are located on the instrument panel in clear view of the pilot.

The fire extinguisher is relocated from its position in the basic aircraft to either:

- back of the pilot's seat (for aircraft with high back composite seat). Refer to Figure 1.
- or
- "AFT laterally" or "LEFT longitudinally" of the pilot's collective housing (for aircraft with energy-absorbing type seat installation). Refer to Figure 1, VIEW A.
- or
- "AFT longitudinally" of the pilot's collective housing (for aircraft with the two-place front seat, installed in accordance with STC SH93-72). Refer to Figure 1, VIEW B.
- or
- back of center console (for aircraft with energy-absorbing type seat installation and extended center console, AS 355 NP version). Refer to Figure 1, VIEW C.

The Aircraft Data Plate, if required, is also relocated to the RH exterior of the aircraft.

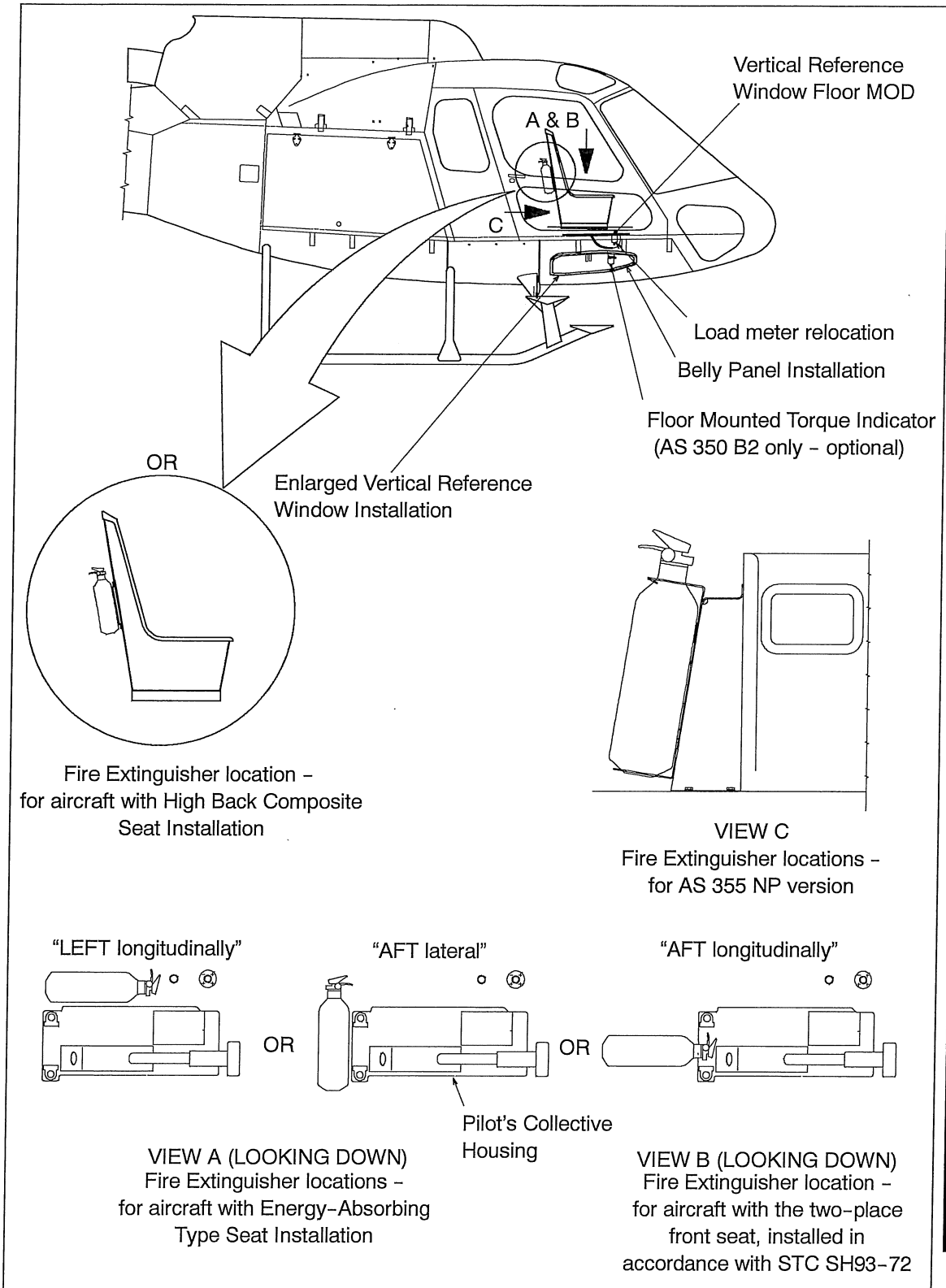

Figure 1 General Layout

Transport Canada Unapproved

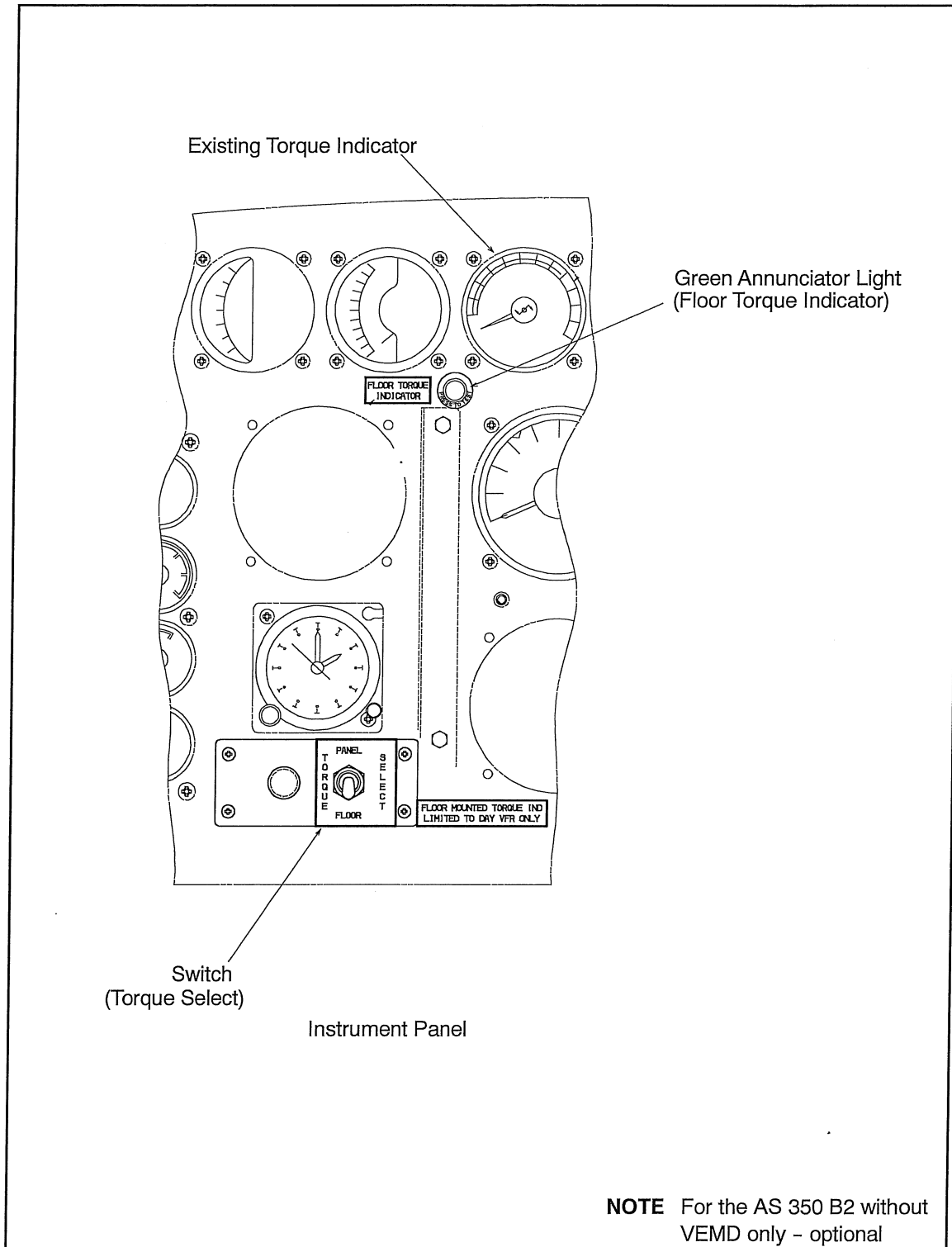

Figure 2 Switch and Annunciator locations for Torque Indicator Option

Transport Canada Unapproved

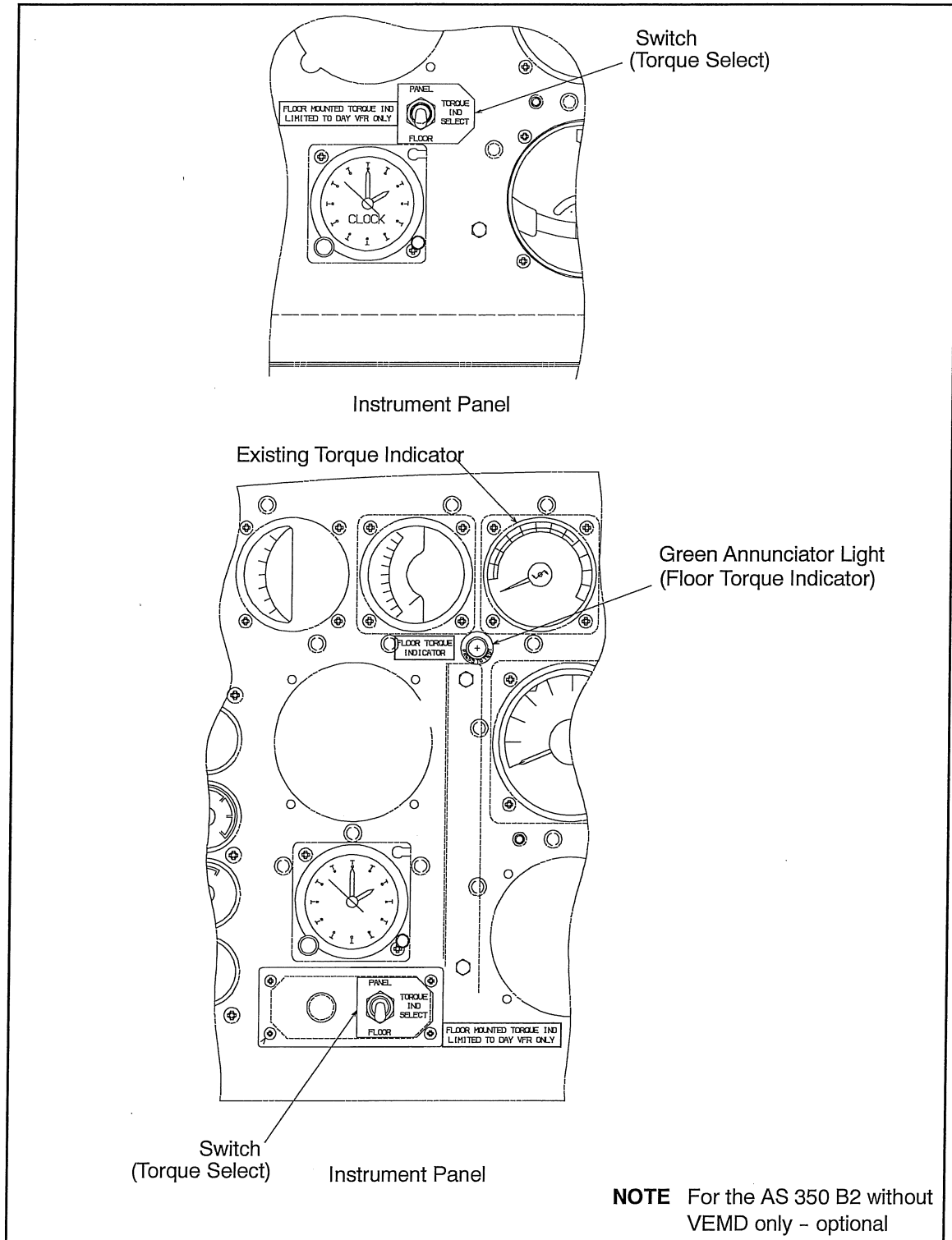

Figure 3 Switch and Annunciator locations for Torque Indicator Option (continued)

Transport Canada Unapproved

1. GENERAL (continued)

Abbreviations and Definitions

ABBREVIATION	DEFINITION
A	Amp
Acc'd	Accepted
AHCA	Airbus Helicopters Canada Limited
AH	Airbus Helicopters (France)
App'd	Approved
A/W	Airworthiness
CAR	Canadian Aviation Regulations
DAPM	Design Approval Procedure Manual
FMS	Flight Manual Supplement
IND	Indicator
LED	Light-Emitting Diode
LHS	Left Hand Side
MOD	Modification
PAI	Aircraft Certification Designator
P/N	Part Number
Rev.	Revision
RH	Right Hand
STC	Supplemental Type Certificate
TCCA	Transport Canada Civil Aviation
VEMD	Vehicle and Engine Multifunction Display
VFR	Visual Flight Rules

Transport Canada - Unapproved

2. LIMITATIONS

All references to the optional Floor Mounted Torque Indicator apply to the AS 350 B2 without VEMD only.

The following Limitations are applicable if the optional Floor Mounted Torque Indicator (AS 350 B2 without VEMD only) is installed.

a. Operation

Operation of the Floor Mounted Torque Indicator is limited to day VFR operation only.

b. Placards

There are three placards associated with the optional Floor Mounted Torque Indicator installation. Placard 1) shows two variants.

1) Placard:

a)

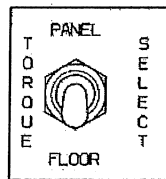

Location: Located adjacent to the torque select switch on the Instrument Panel in clear view of pilot. Refer to Figure 2.

b)

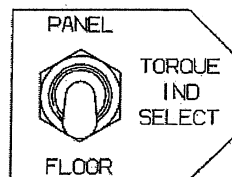

Location: Located adjacent to the torque select switch on the Instrument Panel in clear view of pilot. Refer to Figure 3.

Transport Canada Approved

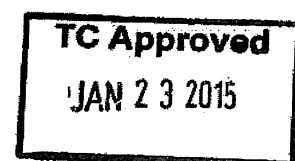



AIRBUS HELICOPTERS CANADA LIMITED

FLIGHT MANUAL SUPPLEMENT
ENLARGED VERTICAL REFERENCE
WINDOW
AS 350 / AS 355

2) Placard:

FLOOR MOUNTED TORQUE IND
LIMITED TO DAY VFR ONLY

Location: Located adjacent to the torque select switch on the Instrument Panel in clear view of pilot. Refer to Figures 2 or 3.

3) Placard:

FLOOR TORQUE
INDICATOR

Location: Located adjacent to annunciator light on the Instrument Panel in clear view of pilot. Refer to Figures 2 or 3.

3. EMERGENCY PROCEDURES

All references to the optional Floor Mounted Torque Indicator apply to the AS 350 B2 without VEMD only.

• **Malfunction of Floor Mounted Torque Indicator** (if installed)

TORQUE SELECT Switch : Select PANEL
(Toggle switch on instrument panel) (Refer to Figures 2 or 3)

4. NORMAL PROCEDURE

All references to the optional Floor Mounted Torque Indicator apply to the AS 350 B2 without VEMD only.

a. **Pre-Flight Check**

The following check is to be carried out prior to every flight requiring the use of the Enlarged Vertical Reference Window.

Cleanliness : Clean floor window and belly panel window

The following check is to be carried out prior to every flight requiring the use of the Floor Mounted Torque Indicator (if installed).

FLOOR TORQUE INDICATOR : LIGHT ON (Refer to Figures
"press to test" green LED 2 or 3)
annunciator light (on instrument panel)

Transport Canada Approved

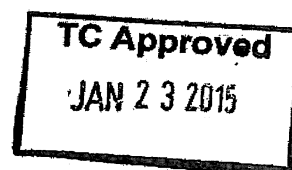

b. Operation

- 1) Floor Mounted Torque Indicator (if installed, refer to Figure 2)

Switches on the Instrument Panel function as follows:

- TORQUE SELECT Switch : Select PANEL to activate panel mounted indicator
: Select FLOOR to activate floor mounted indicator

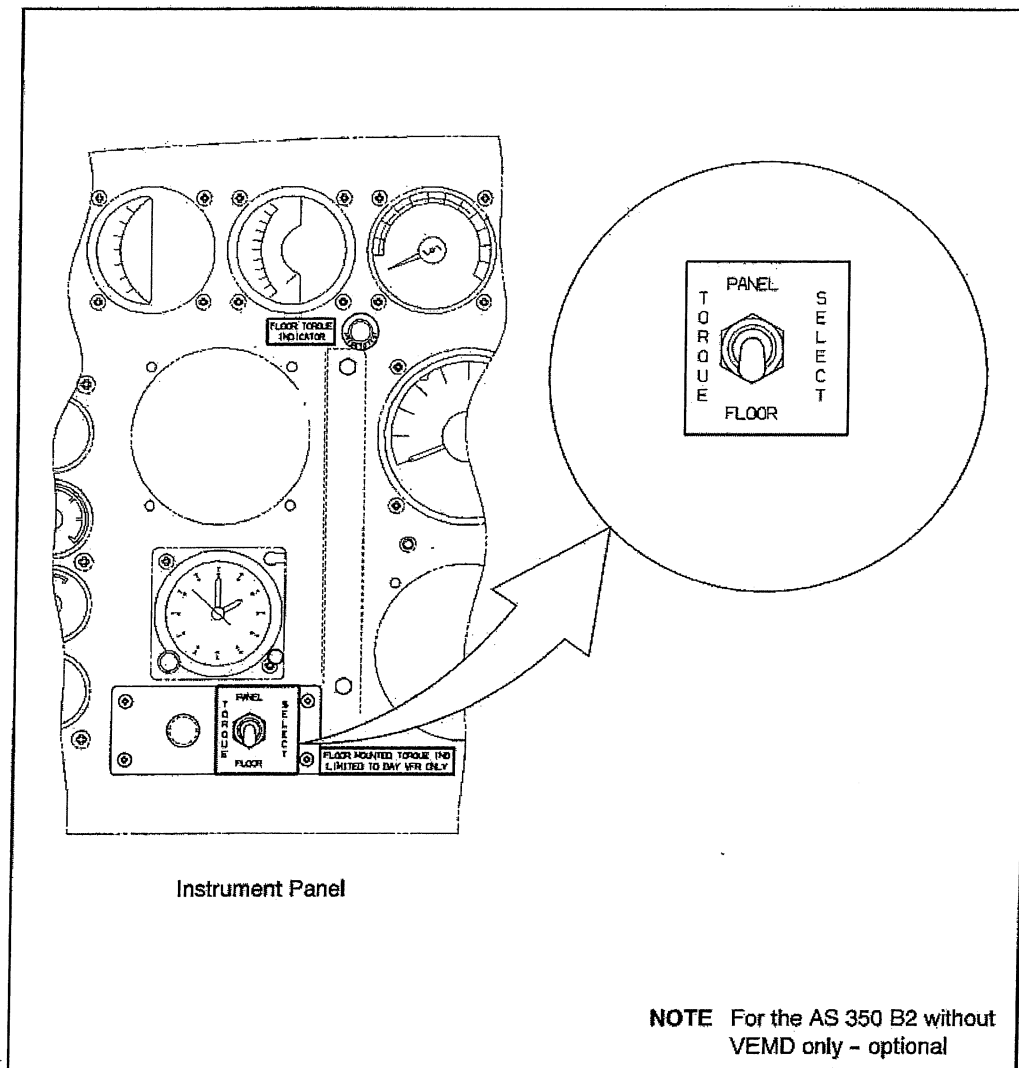

Figure 4 Torque Select Switch locations on the Instrument Panel

Transport Canada Approved

TC Approved
JAN 23 2015

b. Operation

2) Floor Mounted Torque Indicator (if installed, refer to Figure 3)

Switches on the Instrument Panel function as follows:

- | | | |
|----------------------|---|--|
| TORQUE SELECT Switch | : | Select PANEL to activate panel mounted indicator |
| | : | Select FLOOR to activate floor mounted indicator |

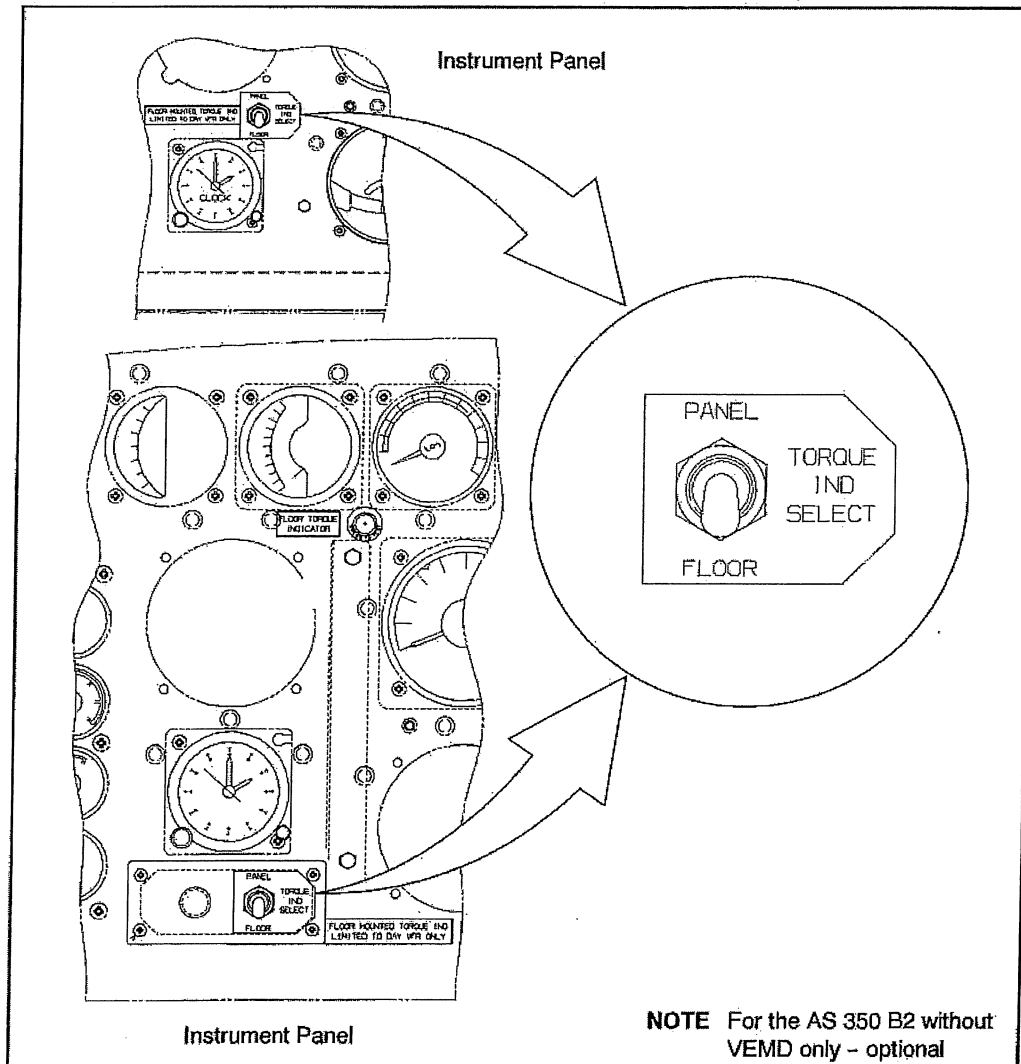

Figure 5 Torque Select Switch locations on the Instrument Panel (continued)

Transport Canada Approved

TC Approved
 JAN 23 2015

b. **Operation** (continued)

- 3) Press to Test Button (if installed, refer to Figure 4)

PRESS TO TEST push button : Push button to test Floor mounted indicator annunciator

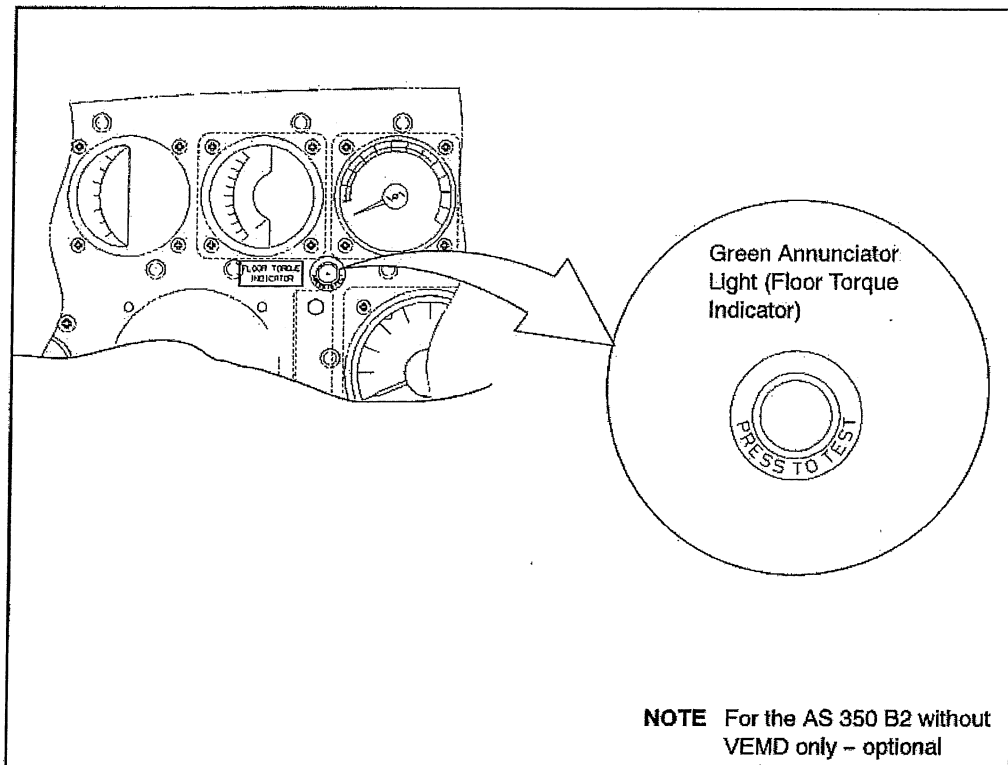
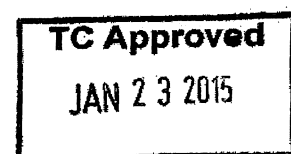

Figure 6 Press to Test Button on the Instrument Panel

5. **PERFORMANCE DATA**

No change.

Transport Canada Approved



6. WEIGHT AND BALANCE (removable items) (unapproved)

Total changes to weight and balance resulting from this modification are covered in the applicable Instructions for Continued Airworthiness.

Items that are removed between routine operations: Not applicable

Transport Canada Unapproved