

# AIRBUS A330-700L

## Aircraft Rescue and Firefighting Chart ARFC

**NOTE:**  
THIS CHART GIVES THE GENERAL LAYOUT OF THE A330-700L STANDARD VERSION. THE NUMBER AND ARRANGEMENT OF THE INDIVIDUAL ITEMS VARY WITH THE CUSTOMERS. FIGURES CONTAINED IN THIS POSTER ARE AVAILABLE SEPARATELY IN THE CHAPTER 10 OF THE "AIRCRAFT CHARACTERISTICS - AIRPORT AND MAINTENANCE PLANNING" DOCUMENT.

**ISSUED BY:**  
AIRBUS S.A.S  
CUSTOMER SERVICES  
TECHNICAL DATA SUPPORT AND SERVICES  
31707 BLAGNAC CEDEX  
FRANCE

**REVISION DATE:** JUNE 2018  
**REFERENCE:** F\_RF\_000000\_1\_A33070L  
**SHEET:** 1/2

© AIRBUS S.A.S. 2018. All rights reserved.

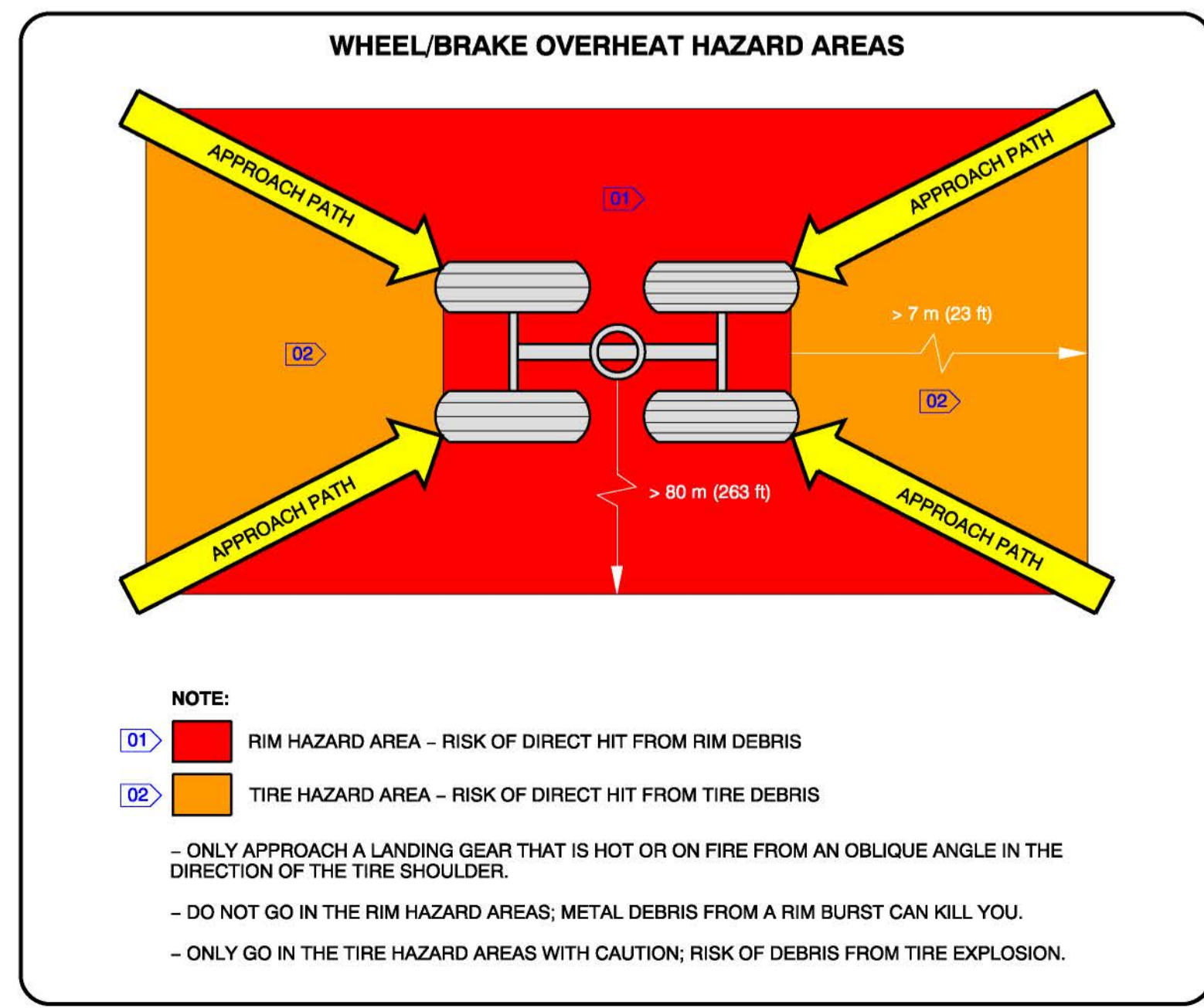
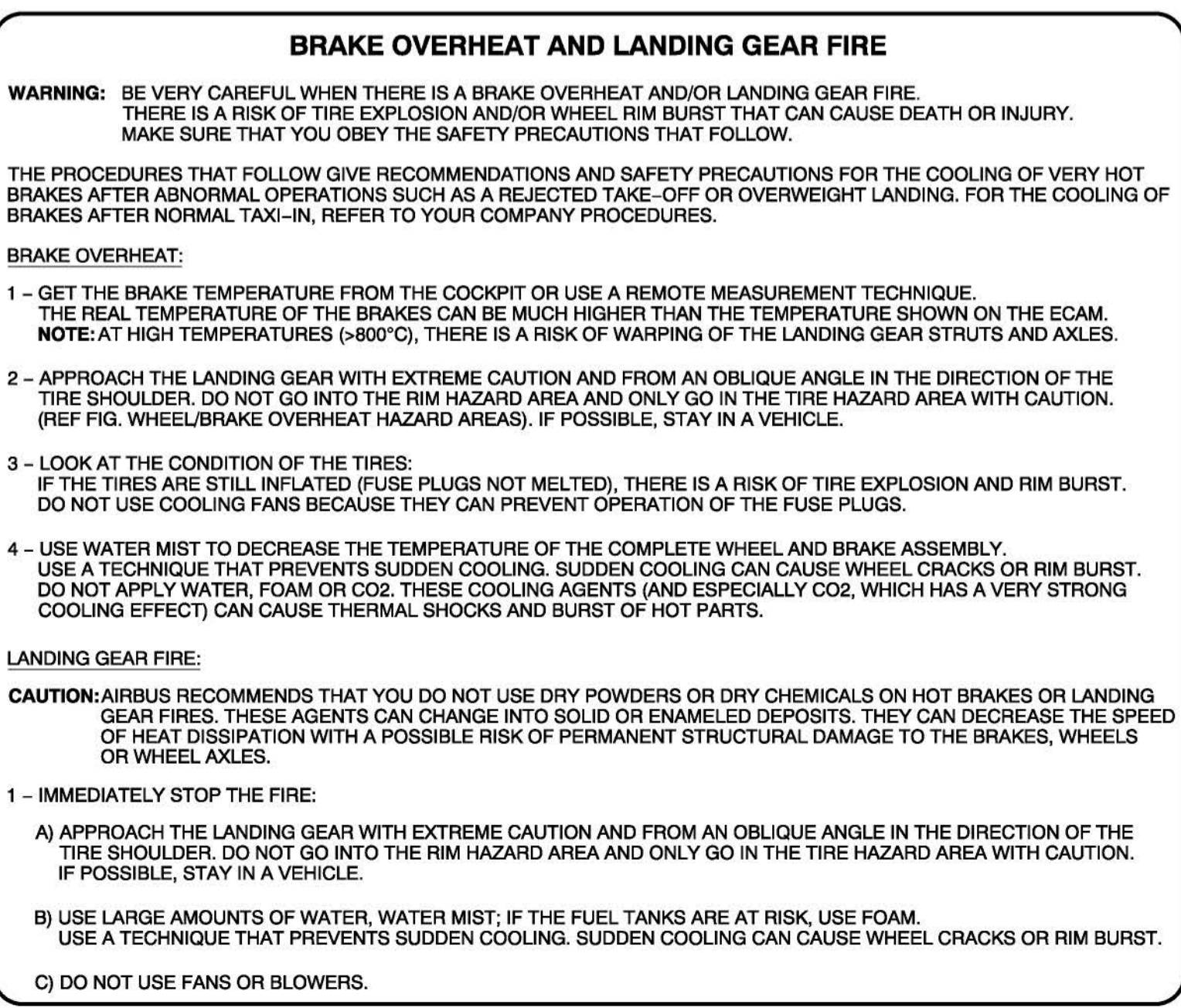
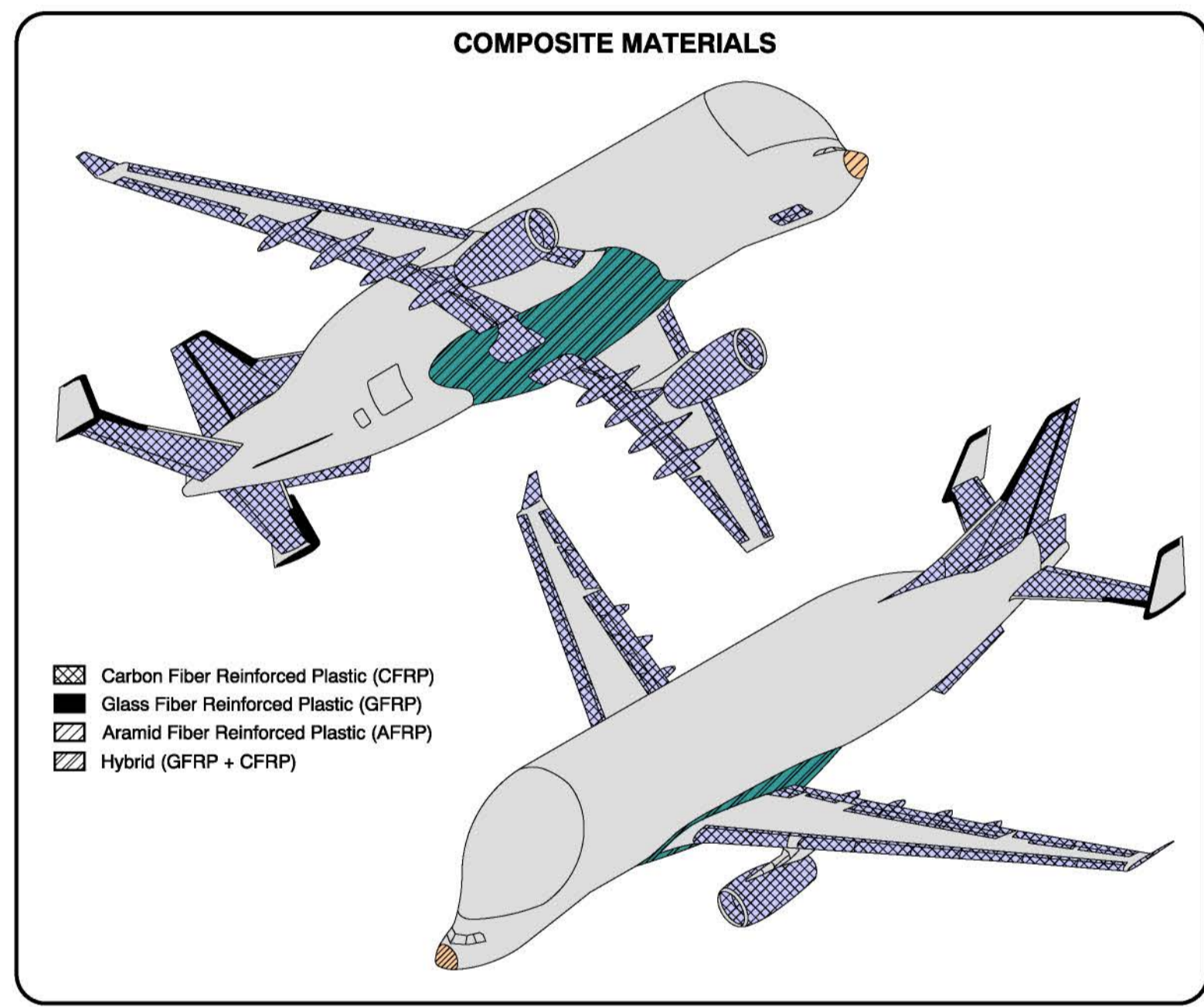
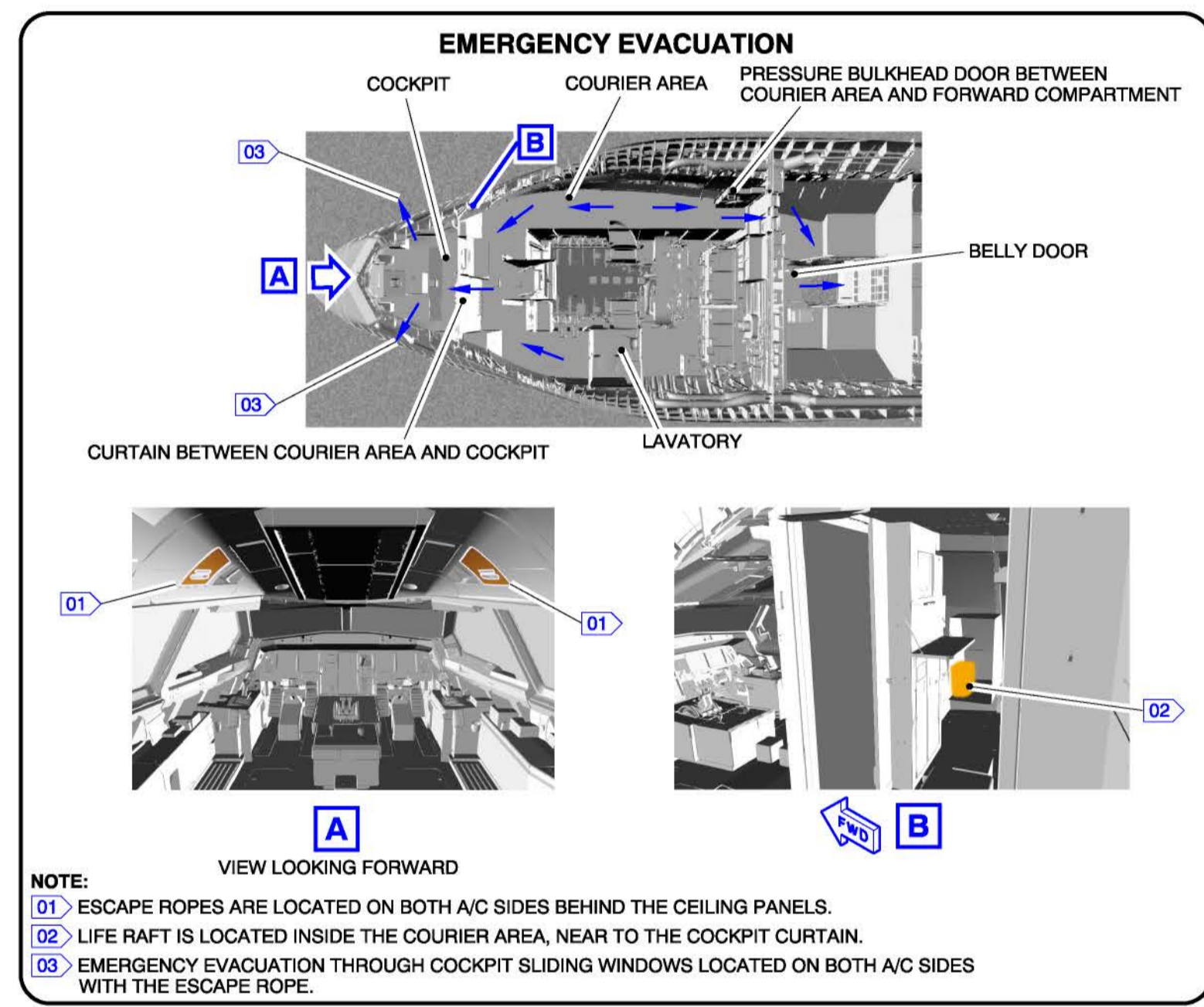
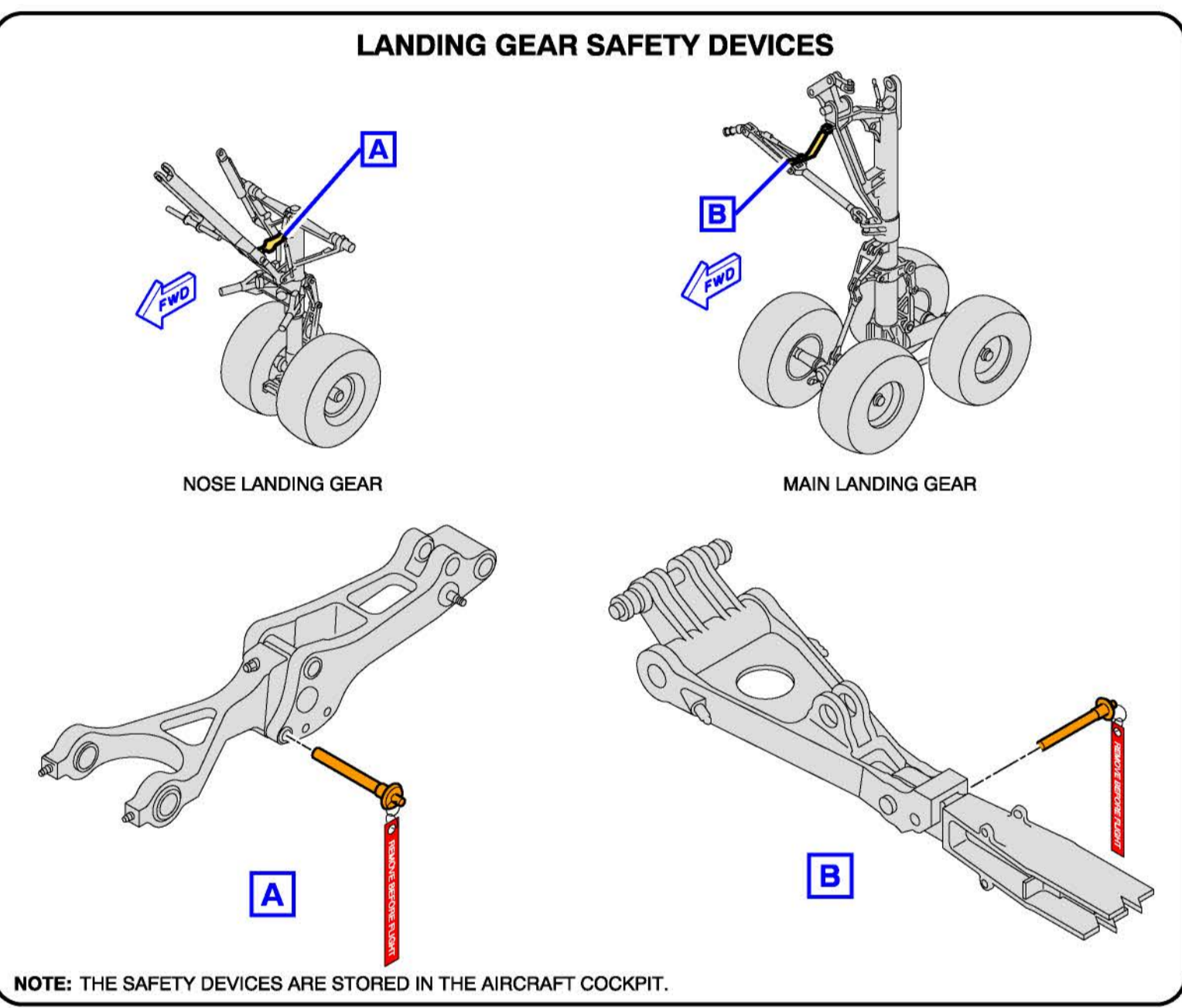
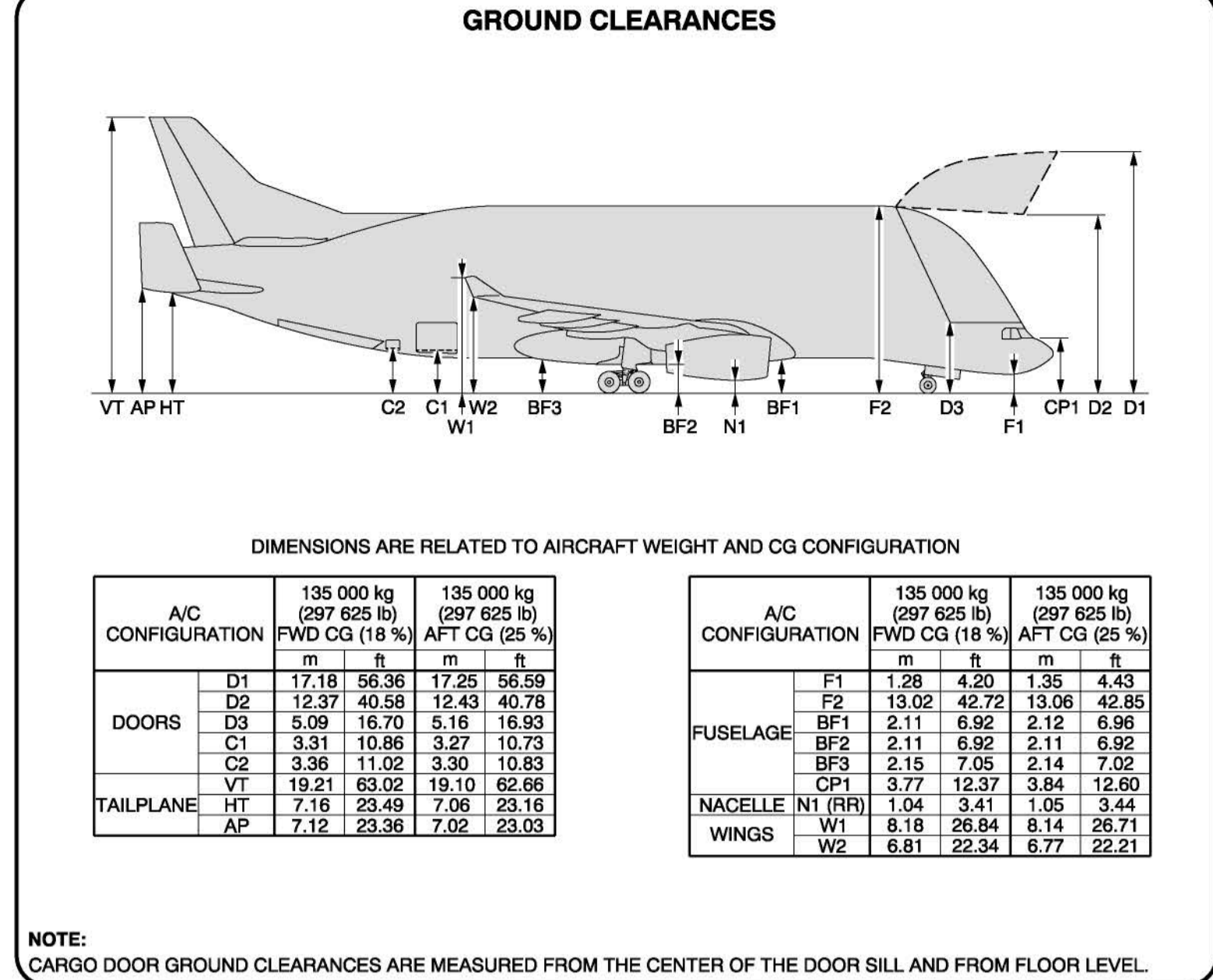
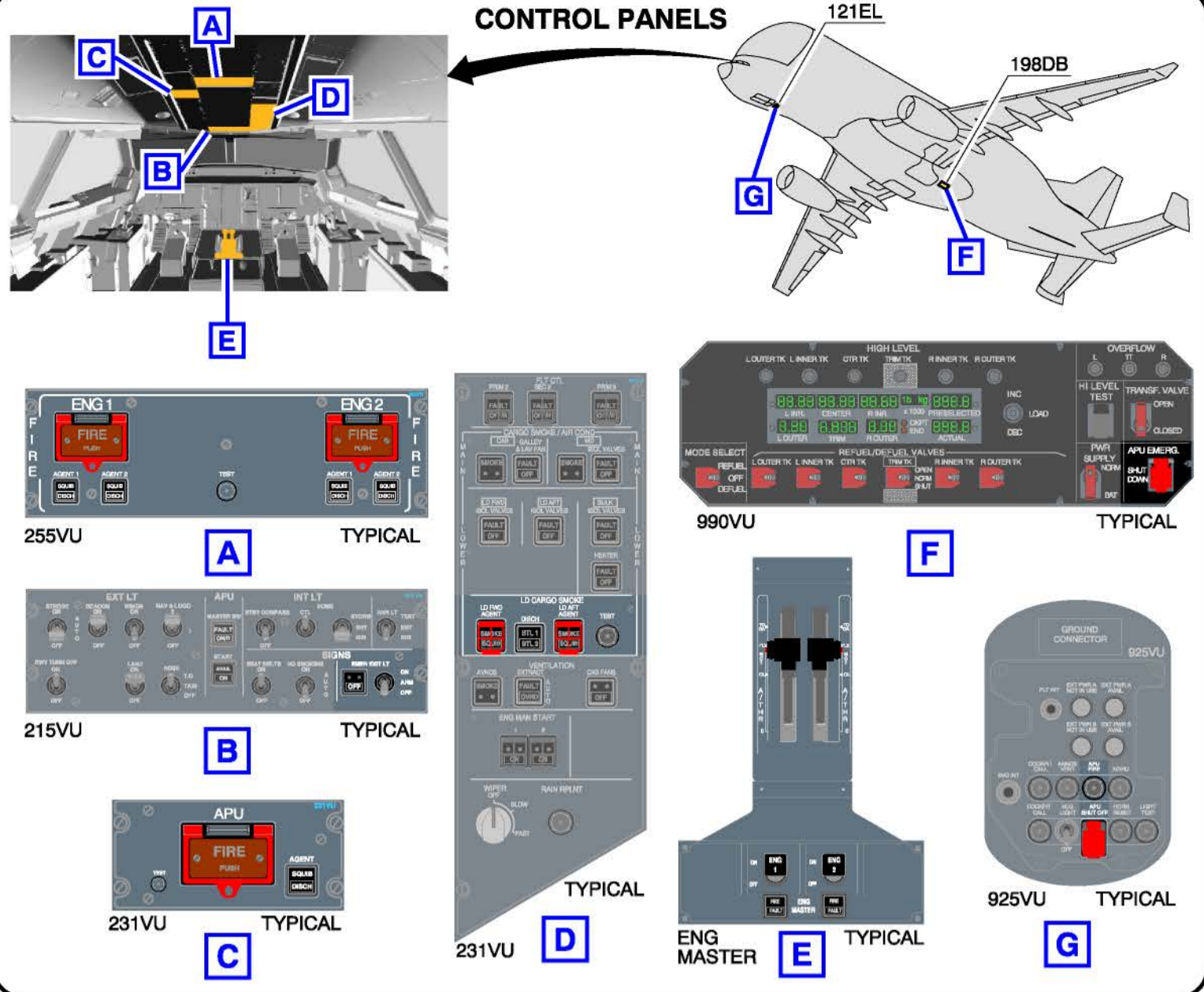

# AIRBUS A330-700L

## Aircraft Rescue and Firefighting Chart ARFC

NOTE: THIS CHART GIVES THE GENERAL LAYOUT OF THE A330-700L STANDARD VERSION. THE NUMBER AND ARRANGEMENT OF THE INDIVIDUAL ITEMS VARY WITH THE CUSTOMERS. FIGURES CONTAINED IN THIS POSTER ARE AVAILABLE SEPARATELY IN THE CHAPTER 10 OF THE "AIRCRAFT CHARACTERISTICS - AIRPORT AND MAINTENANCE PLANNING" DOCUMENT.

ISSUED BY: AIRBUS S.A.S. CUSTOMER SERVICES TECHNICAL DATA SUPPORT AND SERVICES 31707 BLAGNAC CEDEX FRANCE

REVISION DATE: JUNE 2018 REFERENCE : F\_RF\_000000\_1\_A33070L SHEET 2/2

© AIRBUS S.A.S. 2018. All rights reserved.